



B&S
QUALITY MADE

WORKSHOP 2022 | 23

*Doing everything
for healthy glasses*



Dear opticians,

how quickly two years have passed – and what a two years it has been! Never before have we been so aware of the importance of health, well-being and quality of life. Maintaining physical vitality requires more than just sufficient exercise and a healthy diet; we also have to be mindful in how we treat ourselves and our environment. This undoubtedly requires not only a sharp mind but also a clear perspective.

This is why we have once again placed our catalogue theme for the next two years under the motto of health. “Doing everything for healthy glasses 2022/23” is intended to support you in your everyday workshop activities and enable you to achieve the greatest possible feel-good factor for your customers when wearing glasses.

With seven clearly structured and colour-divided chapters, we are right by your side in your workshop – from highly effective measuring devices to precision tools and tailor-made quality pliers, to general consumables and a huge range of small parts for repairs of all kinds. In each chapter, you will also find our “Top Product” award-winning articles, which often have more than one benefit and make your everyday work so much easier.

Last but not least, the “Tips & Tricks” section provides support with its simple and clear instructions for complex work steps. All video tutorials in this series can also be found on our homepage under the “Service” section or on our YouTube channel.

We hope you enjoy reading the more than 30 new articles. Stay healthy!

The B&S team

Contents 2022 | 23



TIPS & TRICKS

Extend your know-how by detailed imaging of complicated work steps and applications



TOP PRODUCT

Selected articles for the efficient design of your working day in the optician's workshop

MACHINES

for prevention and treatment



- A 2 Digital Pupilometers
- A 4 Lensmeters
- A 10 Ultrasonic Cleaning Devices
- A 14 Frame Heaters
- A 20 Lens Groovers
- A 24 Diamond Hand Edgers
- A 26 Polishing Motors
- A 28 Drilling Machines
- A 33 Soldering Units
- A 36 Small Devices
- A 39 Hygiene Box
- A 41 Tinting Unit and Accessories
- A 42 CLAVULUS and Accessories

PLIERS

with pliers every grasp fits

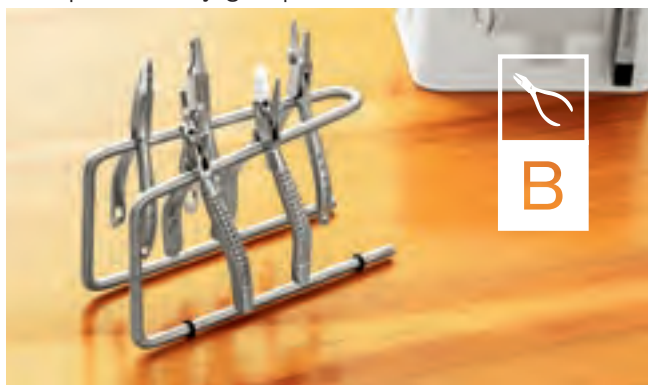

- B 2 Parallel Pliers
- B 4 Overview: eLite-, Standard Pliers
- B 6 Inclination Pliers
- B 8 Holding Pliers
- B 10 Nylon Eyewire Pliers
- B 12 Tips & Tricks: Bending Pliers
- B 16 Flat Snipe Nose Pliers
- B 19 Size Testing Pliers
- B 20 Nose Pad Adjusting Pliers
- B 22 Tips & Tricks: Rimless Frame Pliers
- B 25 Special Front Cutters & -Pliers
- B 30 Tips & Tricks: Bionic Thumb
- B 33 Peening Pliers
- B 34 Lens Aligners
- B 36 De-Blocking Pliers
- B 38 Marking Pliers
- B 39 Side & Front Cutter
- B 43 Tips & Tricks: Spring Hinge Pliers
- B 45 Storage for Pliers
- B 46 Handle Cover for Pliers

PRECISION TOOLS

for complicated procedures



- C 2 Screwdrivers & Nutdrivers
- C 14 Third Hand
- C 15 Rook Anvil
- C 16 Tweezers
- C 18 Cutting Tools
- C 21 Reamers
- C 22 Screw Taps
- C 24 Tips & Tricks: Lens Protection Henry
- C 26 Tips & Tricks: Nylon Liner Tool
- C 27 Rimless Frames Glazing Tools
- C 28 Tips & Tricks: Screw Cutter
- C 31 Small Tools
- C 32 Drills and Millers
- C 37 Tool Holders
- C 38 Files
- C 42 Ball Joint Vices
- C 43 Saws

OPTOMETRY

Tools for the right diagnosis



- D 2 Trial Frames
- D 5 Trial Lens Sets
- D 8 Cross Cylinders and Test Strips
- D 10 Occluder & Colour Charts
- D 11 Tips & Tricks: Prism Foils
- D 12 Ophthalmic Lenses
- D 13 Stick-on Reading Segment
- D 14 Occluders
- D 15 Occlusion Foils
- D 16 Eye Patches Picolo
- D 18 Contact Lens Equipment
- D 22 Lens Clock and Thickness Gauge
- D 24 Caliper Gauges
- D 26 Tips & Tricks: The Cube
- D 29 Rulers

CONSUMABLES

for first aid measures



- E 2 Lens Blocks and Adhesive Pads
- E 8 Lens Protection and Anti-Torsion Foil
- E 9 Anti-Foaming Agent and Abrasive Stones
- E 10 Lens Marking Pens
- E 11 UV Gel
- E 12 Glues and Screw Securing
- E 17 Oil and Cleaners
- E 20 Dyes
- E 22 Tips & Tricks: Plasti Dip
- E 24 Repair Colours and Repair Pens
- E 27 Tips & Tricks: Polishing
- E 28 Buffing Wheels and Brushes
- E 30 Polishing and Grinding Wax
- E 32 Marking and Emery Tools
- E 34 Solder and Flux

SPECTACLE FRAME PARTS

in exact dosage with targeted effect



- F 2 Overview: Nose Pads
- F 10 Tips & Tricks: Silicone Nose Pads Minifits
- F 15 Nose Pad Cushions
- F 16 Tips & Tricks: Self-adhesive Nose Pad Cushion
- F 18 Tips & Tricks: Nose Pad Arms
- F 19 Nose Pad Arms
- F 22 Overview: Screws and Nuts
- F 35 Tips & Tricks: 4-in-1 Screws
- F 49 Nuts, Washers and Sleeves
- F 54 Hinges
- F 58 Overview: Temples and Temple Ends
- F 66 Tips & Tricks: Sport Temple Ends
- F 75 Long Temple Ends
- F 76 Tips & Tricks: Heat Shrink Tube
- F 78 Temples
- F 81 Spare Parts for Rimless Frames with Sleeves Mounting
- F 84 Lens Washer
- F 85 Nylon Threads
- F 86 Exercise Samples for Trainees

ORGANISING AIDS

for the effective treatment plan



- G 2 Presentation Trays
- G 3 Job Bags
- G 5 Price Tags
- G 6 Job Trays
- G 10 Assortment Boxes and Hinged Boxes
- G 14 Cosmetic Mirrors





MACHINES

for prevention and treatment



- A 2 Digital Pupilometers
- A 4 Lensmeters
- A 10 Ultrasonic Cleaning Devices
- A 14 Frame Heaters
- A 20 Lens Groovers
- A 24 Diamond Hand Edgers
- A 26 Polishing Motors
- A 28 Drilling Machines
- A 33 Soldering Units
- A 36 Small Devices
- A 39 Hygiene Box
- A 41 Tinting Unit and Accessories
- A 42 CLAVULUS and Accessories

Often copied, never matched!

Made in Japan, the PD meter's excellent workmanship, ergonomics and outstanding design make it an attractive product. Simple and easy to use, with a digital display, integrated CVD measurement and of course its excellent design is a prime example of the ideal combination of design and function. The Design PD meter will make your spectacle dispensing stand out twice as clearly.

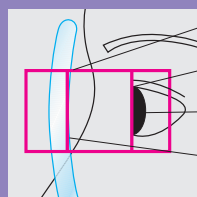

PD indication line
Stationary corneal line
Top of the cornea
Back of lens

Total PD measurement LCD

Single PD-display

Switch to change from PD measurement to back vertex measurement



Off/On switch

Smooth measurement slider

Adjustable focal distance: 30 cm to ∞

Enlargement switch for spectacle wearer

B & S Design Pupillometer

The superb ergonomically designed PD measuring device from B & S, sits perfectly in the hand.

- Switch to select between monocular and binocular measurement
- Illuminated focal point ensures easy reading from the corneal reflection
- Large, easily readable LC display with simultaneous display of total and individual PD
- Switch to select between PD measurement and CVD measurement
- Continuous measurement of the PD
- Battery saving feature automatically switches off after 1 minute
- Enlargement switch for spectacle wearer

120 2866
2385 00

Technical data

Display:	LC display
Focusing:	Light circle
Measurement range	
Binocular:	46.0 to 82.0 mm in steps of 0.5 mm
Monocular:	23.0 to 41.0 mm in steps of 0.5 mm
Measuring distance can be selected from:	30, 35, 40, 50, 65 cm; 1.0, 2.0 m; ∞
Voltage supply:	4 x 1.5 V Micro (type AAA)
Size (w x h x d):	155 x 52 x 220 mm
Weight:	655 g incl. batteries

36 month warranty!

For spare parts contact your local distributor.



Pupilometer

Pupilometer with digital display for simple and precise measurement of the pupil distance.

- Switch to select between monocular and binocular measurement
- Illuminated focal point ensures easy reading from the corneal reflection
- Large, easily readable LC display with simultaneous display of total and individual PD
- Switch to select between PD measurement and CVD measurement
- Enlargement switch for spectacle wearer

Technical data	
Display:	LC display
Focusing:	Light circle
Measured range	
Binocular:	45.0 to 82.0 mm in steps of 0.5 mm
Monocular:	22.5 to 41.0 mm in steps of 0.5 mm
Measuring distance can be selected from:	30, 35, 40, 50, 65 cm; 1.0, 2.0 m; ∞
Voltage supply:	2 x 1.5 V Mignon (type AA)
Size (w x h x d):	166 x 63 x 221 mm
Weight:	680 g

120 2871
2387 00

 **12 month warranty!**

 For **spare parts** contact your local distributor.

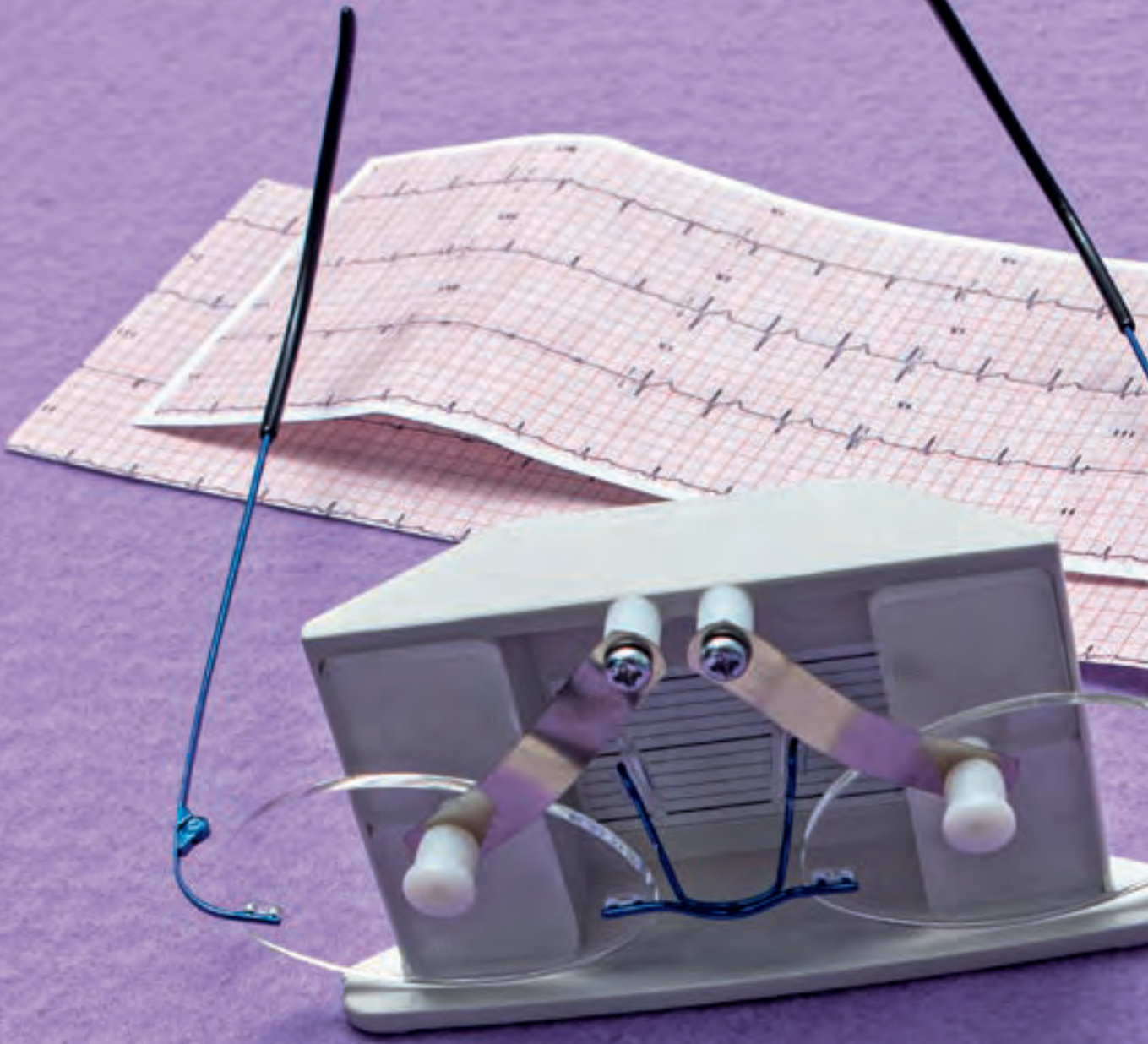

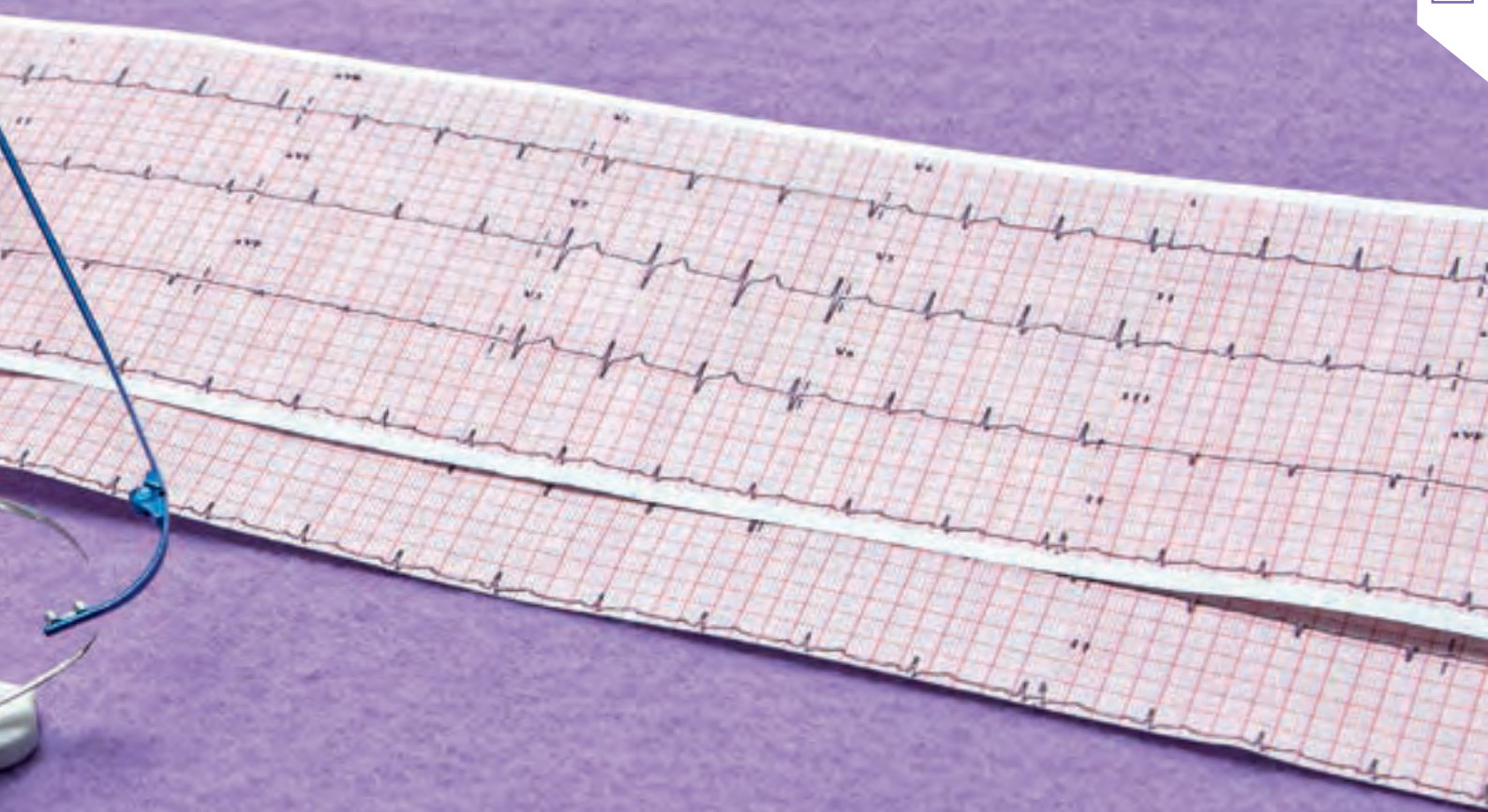

Automatic Lensmeter BS-5000

- Wavefront measuring with Hartmann-Sensor
- LCD colour touch-screen
- Automatic measurement
- Automatic measuring for progressive lenses
- Measurement of the UV transmission, PD and PH
- Measurement of the blue light filter
- Contact lens mode
- Displays resultant prism
- Built-in thermal printer
- Supplied in aluminium case

120 2801

2354 10

 **12 month warranty!**

 For **spare parts** contact your local distributor.



Exclusive to B & S



Delivery occurs in a precisely fitting aluminium case.



Automatic Lensmeter BS-4000 WF

- Hartmann Sensor technology
- LCD colour touch-screen
- Automatic measurement
- Automatic measuring of progressive lenses
- Measurement of the UV transmission and PD
- Contact lens mode
- Display of the resultant prism
- Built-in thermal printer
- Supplied in aluminium case

120 2820

2357 10



12 month warranty!



For **spare parts** contact your local distributor.



Exclusive to B & S

Accessories for BS-4000 WF and BS-5000

Ink Cartridges

- For **special coated** and uncoated lenses
- High contrast during the centering and blocking process of lenses, especially for tinted lenses



White



Red

120 2826

2357 60



3 pieces

120 2827

2357 61



3 pieces



Printing Paper

- Roll width: 55 mm
- Roll diameter: 25 mm

120 2824

2357 51



3 rolls

120 2825

2357 52



10 rolls



Ocular Lensmeter

- Adjustment of the body angle
- Easy to handle
- Bright and clear visible measuring mark
- Internal reading
- Including prism compensator
- Marking system: with ink pad

Standard equipment:

- 1 ink pad, 1x box of ink, 1 dust cover

120 2810

2355 20



12 month warranty!



For **spare parts** contact your local distributor.



Accessories for Ocular Lensmeter

Ink for Ocular Lensmeter

120 2809

2355 19

Technical Data for all Devices at a Glance

Technical data	120 2801 ^{2354 10} BS-5000	120 2820 ^{2357 10} BS-4000 WF	120 2810 ^{2355 20} Ocular
Measuring range			
Sphere:	- 25 to + 25 dpt.	- 25 to + 25 dpt.	- 25 to + 25 dpt.
Cylinder:	- 10 to + 10 dpt.	- 10 to + 10 dpt.	- 25 to + 25 dpt.
Axis:	0° to 180°	0° to 180°	0° to 180°
Addition:	0 to 10 dpt.	0 to 10 dpt.	all in the measuring range
Prism:	0 to 20 Δ	0 to 15 Δ	0 to 20 Δ
Measuring units			
Diopters:	0.01/0.06/0.12/0.25 dpt.	0.01/0.12/0.25 dpt.	0.125 dpt. to ± 5.0 dpt. 0.25 dpt. to ± 5.0 dpt.
Prism:	0.25 Δ	0.01/0.12/0.25 Δ	0.5 dpt. to ± 2.0 dpt. 1.0 dpt. to ± 2.0 dpt.
Prism display:	Cartesian and polar coordinates	Cartesian and polar coordinates	Polar coordinates
Measurements			
Optical measuring light Ø:	8 mm	8 mm	
Pupil distance (steps 0.5 mm):	42 to 82 mm	50 to 86 mm	
UV transmission 0 to 100 % (375 nm):	X	X	
Measures standard lenses:	X	X	X
Measures bifocals:	X	X	X
Measures trifocals:	X	X	X
Measures progressive lenses:	X	X	
Measures contact lenses:	X	X	
Monitor display			
Colour touch-screen:	X	X	
External communication			
Serial interface RS-232C:	X	X	
General			
Thermal printer:	X	X	
Power:	35 W	25 W	35 W
Power usage per 10 min:	0.0058 kWh	0.0042 kWh	0.0058 kWh
Voltage:	240 V	240 V	240 V
Size (w x h x d):	203 x 471 x 233 mm	161 x 372 x 222 mm	150 x 450 x 280 mm
Weight:	4.5 kg	5.5 kg	4.9 kg

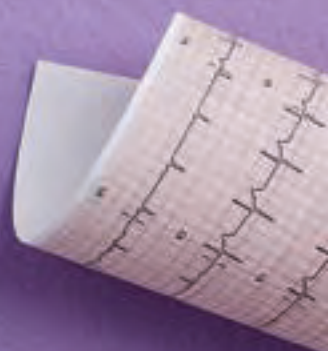

OPTOSONIC Cleaning Devices Professional unit “MADE IN GERMANY”

Optimized results

- Perfect cleaning by adapted 37 kHz technology
- Sweep function for optimum distribution of the sonic field in the tank
- Degas function for effective cleaning

Extensive equipment

- Cleaning tank made of corrosion resistant stainless steel – provides quick and efficient cleaning
- Stainless steel housing, extremely durable and easy to clean
- Noise reducing cover

Easy handling

- User-friendly, sealed operating controls
- Rotary switch for pre-selecting the cleaning time between 1 and 30 min
- LED function indicator for a quick overview

OPTOSONIC Silence “The Silent Classic”

- Exceptionally quiet when operating, ideal for the dispensing area
- Cleaning frequency 80 kHz
- Compact and robust unit with 0.8 l tank

120 3810

2977 00

Technical data	
Tank (w x h x d):	190 x 60 x 85 mm
Tank capacity:	approx. 0.8 l
Frequency:	80 kHz
Power:	30 W
Power usage per 10 min:	0.005 kWh
Voltage:	230 V
Size (w x h x d):	206 x 178 x 116 mm
Weight:	2 kg
Available baskets:	120 3794 2971 02, 120 3802 2974 10



36 month warranty!





OPTOSONIC “The Classic”

- Reliable device with 0.8 l tank

120 3801
2974 00

36 month warranty!



For **spare parts** contact your local distributor.



OPTOSONIC “The Advanced”

- Comfortable device with 2.8 l tank
- Rotary switch on the side for draining the cleaning fluid.
Outlet valve on the rear of the machine
- Carrying handle in plastic
- More cleaning power, thus better cleaning effect

120 3806
2975 00

36 month warranty!



For **spare parts** contact your local distributor.



OPTOSONIC “The Advanced – including Heating”

Technically as No. 120 3806, plus in addition:

- The cleaning process can be started with or without temperature control
- Heating protected against dry operation for an even better cleaning result
- Rotary switch to adjust temperature setting between 30 and 80 °C in 5 steps
- LED for desired and actual values for the temperature of the fluid

120 3809
2976 00

36 month warranty!



For **spare parts** contact your local distributor.



Technical data	120 3801 2974 00	120 3806 2975 00	120 3809 2976 00
Tank (w x h x d):	190 x 60 x 85 mm	240 x 100 x 137 mm	240 x 100 x 137 mm
Tank capacity:	approx. 0.8 l	approx. 2.8 l	approx. 2.8 l
Frequency:	37 kHz	37 kHz	37 kHz
Power:	30 W	80 W	280 W, including 200 W for integrated heater
Power usage per 10 min:	0.005 kWh	0.0133 kWh	0.0467 kWh
Voltage:	230 V	230 V	230 V
Size (w x h x d):	206 x 178 x 116 mm	300 x 214 x 179 mm	300 x 214 x 179 mm
Weight:	2 kg	3.3 kg	3.3 kg
Available baskets:	120 3794 2971 02, 120 3802 2974 10	120 3807 2975 10	120 3807 2975 10

Elmasonic P30H

- Multi-frequency technology with 37/80 kHz
- 37 kHz for standard cleaning process and 80 kHz for finer cleaning processes with increased cleaning time, very quiet
- Comfortable device with 2.8 l tank
- Rotary switch on the side for draining the cleaning fluid.
Outlet valve on the rear of the machine
- Carrying handle in plastic
- More cleaning power, thus better cleaning effect
- The cleaning process can be started with or without temperature control
- Heating protected against dry operation for an even better cleaning result
- Rotary switch to adjust temperature setting between 30 and 80 °C in 5 steps
- LED for desired and actual values for the temperature of the fluid

120 3811
2978 00



36 month warranty!



For **spare parts** contact your local distributor.

Technical data	
Tank (w x h x d):	240 x 100 x 137 mm
Tank capacity:	approx. 2.8 l
Frequency:	37 kHz, 80 kHz
Power:	350 W including 320 W for integrated heater
Power usage per 10 min:	0.0583 kWh
Voltage:	230 V
Size (w x h x d):	300 x 214 x 179 mm
Weight:	3.3 kg
Available basket:	120 3807 2975 10



Built-in Ultrasonic Cleaner

- New compact device: container and generator in the same housing, separate control panel with timer
- With integrated drain for easy fitting in service desks
- Same technique as unit No. 120 3801 (see page A 11); e.g. with permanent sweep-function for perfect cleaning results
- Optional available: Built-In Rinsing container No. 120 3791, without drain

120 3790
2970 10



36 month warranty!



For **spare parts** contact your local distributor.

Technical data	
Tank (w x h x d):	190 x 60 x 85 mm
Tank capacity:	approx. 0.8 l
Frequency:	37 kHz
Power:	30 W
Power usage per 10 min:	0.005 kWh
Voltage:	230 V
Size (w x h x d):	206 x 178 x 116 mm
Weight:	2 kg
Available basket:	120 3802 2974 10







Accessories

Rinsing Container for 120 3790

Without drain.

120 3791
2970 11

 190 x 75 x 85 mm  740 g



Metal Basket

For ultrasonic cleaners No. 120 3790, 120 3801 and 120 3810.

120 3802
2974 10

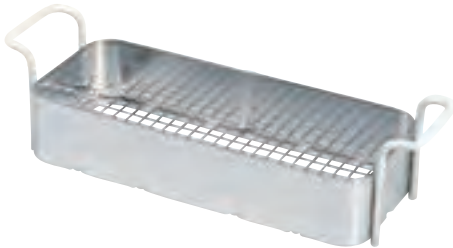

 177 x 35 x 74 mm without handles  211 g



Metal Basket

For ultrasonic cleaners No. 120 3806, 120 3809 and 120 3811.

120 3807
2975 10



 200 x 55 x 107 mm without handles  400 g



Plastic Basket

For ultrasonic cleaners No. 120 3790, 120 3801 and 120 3810.

120 3794
2971 02

 185 x 47 x 85 mm  49 g

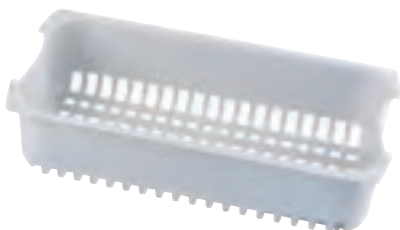

You will find our OPTOCLEAN and the cleaning concentrate on page E 19.

A must for all opticians who place value on comfortable working and good design.

This device shows competence and is perfect for working in the sales area. The OPTIFORMA can be built into the service desk. Frames can be heated in almost total silence. A digital temperature and time setting for gentle processing of sensitive materials is an expression of a genuine quality product made in Germany.



OPTIFORMA Profi

- Quiet running
- Stepless temperature and time setting via LCD and keys
- Menu driven handling
- Installed overheat protection
- Auto cut out if unit is knocked over in case of device inclination
- Automatic cooling phase
- Can be built into work bench or service desk, installation depth: 145 mm
- Including a template to use on a work top with a max. of 28 mm thickness
- Distance between the air jets: 45 mm
- Including spot heating jet

 Black/Grey

120 3184
2872 01

Template for OPTIFORMA Profi No. 120 3184

120 3190
2872 25

Technical data

Temperature scale:	60 to 140 °C
Adjustable operating time:	50 to 249 s
Overheating protection through thermo switch	
Power:	800 W
Power usage per 10 min:	0.1333 kWh
Voltage:	230 V
Size (w x h x d):	230 x 228 x 275 mm
Weight:	2.1 kg

 **36 month warranty!**

 For **spare parts** contact your local distributor.



● Design-
Zentrum
Nordrhein-
Westfalen

Design innovations
Award for
high quality design



OPTIFORMA Standard

- Temperature level adjustable using a potentiometer
- Additional device for pointed heating
- Auto cut out if unit is knocked over in case of device inclination
- Thermal overload protection
- Distance between the air jets: 45 mm

 Black/Grey

120 3171
2871 01

Technical data	
Temperature scale:	80 to 140 °C
Overheating protection through thermo switch	
Power:	800 W
Power usage per 10 min:	0.1333 kWh
Voltage:	230 V
Size (w x h x d):	170 x 228 x 190 mm
Weight:	1.5 kg

 **36 month warranty!**

 For **spare parts** contact your local distributor.

An optimized Classic

In cooperation with the technical university of Aalen we made a study to optimize the heat distribution in the cup which is used in this new generation of the OPTIMONSUN.

This branded product made in Germany corresponds with the highest requirements. The electronic version offers an additional third program which is designed for wood and horn processing at higher temperatures (180–230 °C).

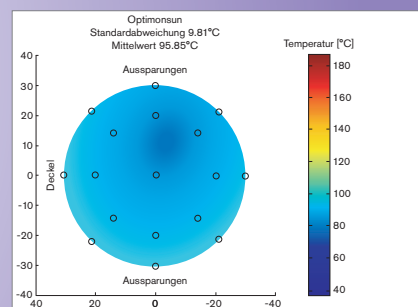
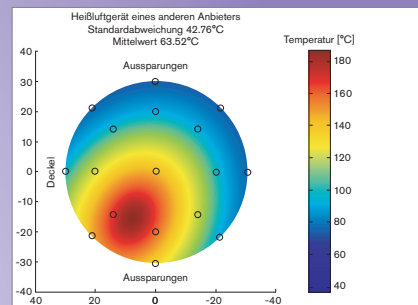

Design Frame Heater OPTIMONSUN

- New design unit with especially even temperature distribution in the cup
- More comfortable handling of the frame due to an optimised opening in the cup
- Thermal overload control
- With plastic cup diam. 85 mm, slit width 30 mm, slit depth 34 mm
- Including spot heating jet
- 2,5 m helix cable (2 m normal cable with built-in unit)



120 3127
2865 00
White



120 3128
2865 01
Metallic
Black



120 3129
2865 02
Metallic
Grey



120 3130
2865 03
Blue

120 3127–30

Design Frame Heater OPTIMONSUN Electronic

Technically like as specified above but also features:

- Movement sensor for comfortable working
- 3 different settings (non-stop use, 10 min, horn program up to 230 °C)
- With constant electronic temperature control, temperature adjustable
- Automatic switch off after 3 hours
- Including additional slot heating jet



120 3143
2866 00
White



120 3144
2866 01
Metallic
Black



120 3145
2866 02
Metallic
Grey



120 3146
2866 03
Blue

120 3143–46

36 month warranty!

For spare parts contact your local distributor.

Technical data	OPTIMONSUN D	OPTIMONSUN D Electronic
Temperature:	180 °C	min. 60 °C, max. 230 °C
Temperature with spot heating jet:	max. 200 °C	max. 240 °C
Temperature regulation:	no	10°-steps
Power:	155 W	300 W
Power usage per 10 min:	0.0258 kWh	0.0499 kWh
Voltage:	230 V	230 V
Size (w x h x d):	190 x 265 x 190 mm	190 x 265 x 190 mm
Weight:	1.7 kg	1.7 kg



120 3158
2867 10

Frame Heater OPTIMONSUN

- With plastic cup Ø 85 mm, slit width 30 mm, slit depth 20 mm
- **Without** temperature control
- Metal housing
- 2 m helix cable

120 3156-60



36 month warranty!



For **spare parts** contact your local distributor.



120 3156
2867 01
Metallic
Black



120 3158
2867 10
Metallic
Grey



120 3159
2867 15
Blue



120 3160
2867 22
White

Frame Heater OPTIMONSUN Electronic

Technically like 120 3156-60, but also features:

- With constant electronic temperature control, temperature variable adjustable

120 3165-68



36 month warranty!



For **spare parts** contact your local distributor.



120 3165
2869 01
Metallic
Black



120 3166
2869 10
Metallic
Grey



120 3167
2869 15
Blue



120 3168
2869 22
White

120 3167
2869 15



Technical data	OPTIMONSUN	OPTIMONSUN Electronic
Temperature:	max. 180 °C	min. 65 °C, max. 180 °C
Temperature with spot heating jet:	max. 200 °C	max. 200 °C
Temperature control:	no	adjustable
Power:	215 W	250 W
Power usage per 10 min:	0.0358 kWh	0.0417 kWh
Voltage:	230 V	230 V
Size (w x h x d):	100 x 250 x 160 mm	100 x 250 x 160 mm
Weight:	1.3 kg	1.7 kg

Frame Heater Fata Up Plus/Fata up

- The quiet and efficient helper during frame adjustments
- Very light, quiet running heater with or without temperature control
- Including spot heating jet

Fata up Plus (with temperature control)

120 3214

2878 00

Fata up (without temperature control)

120 3216

2878 10

Technical data

Temperature:	0–150 °C
Power:	350 W
Power usage per 10 min:	0.0583 kWh
Voltage:	230 V
Size (w x h x d):	120 x 320 x 180 mm
Weight:	1.9 kg

60 month warranty!

 For **spare parts** contact your local distributor.



Frame Heater Zita Plus

- With constant electronic temperature control
- Adjustable
- Distance between the air jets: 35 mm
- Including spot heating jet
- Metal housing

120 3194

2875 00

Technical data

Temperature level I:	to 75 °C
Temperature level II:	to 150 °C
Power:	900 W
Power usage per 10 min:	0.1499 kWh
Voltage:	230 V
Size (w x h x d):	144 x 213 x 200 mm
Weight:	1.46 kg

60 month warranty!

 For **spare parts** contact your local distributor.





Frame Heater Maga S

- Very strong laboratory heater with heat from both sides
- Two electronically controlled temperature settings.
- Distance between the air jets: 45 mm
- Including spot heating jet
- Metal housing

120 3200
2876 00

Technical data	
Temperature level I:	to 75 °C
Temperature level II:	to 150 °C
Power:	1,500 W
Power usage per 10 min:	0.2499 kW
Voltage:	230 V
Size (w x h x d):	190 x 215 x 315 mm
Weight:	3 kg

 **60 month warranty!**

 For **spare parts** contact your local distributor.



VENTILETTE Model 3

- With plastic cup Ø 80 mm, slit width 30 mm
- Casing and stand are made of aluminium
- Motor on rubber support for quieter running
- Universal motor for alternating current (AC) and direct current (DC)
- Extremely long carbon brushes increase service life span of motor
- With hot and cold switch

120 3114
2861 22



VENTILETTE Model 3, Electronic

- Same as No. 120 3114, however with adjustable temperature level

120 3117
2861 42



Technical data	120 3114 2861 22	120 3117 2861 42
Temperature level:	to max. 160 °C	40 to 200 °C (adjustable)
Power:	450 W	800 W
Power usage per 10 min:	0.0749 kWh	0.1333 kWh
Voltage:	230 V	230 V
Size (w x h x d):	275 x 135 x 145 (Ø stand) mm	275 x 135 x 145 (Ø stand) mm
Weight:	1.3 kg	1.6 kg

 **36 month warranty!**

 For **spare parts** contact your local distributor.

The original from Japan is really unique:

With high quality materials like brass bushing and quality bearings, a fully developed motor technology and perfectly manufactured.

For professional use, for high reliability, for better results than ever before. Key reasons for us to recommend this high quality machine.



TAKUBOMATIC Lens Groover

- Large, specially supported guide rollers enable grooving of even difficult lens shapes
- Stepless adjustable groove depth
- Grooving parallel to rear face possible
- 4 different grooving types to choose from:
 - Controlled grooving parallel to front or back surface
 - Free wheel grooving
 - Manual controlled grooving
- No adaption on lens curvature necessary
- With an easy change it's possible to make a lenti cut by using No. 120 3282
- Including standard groove wheels (0.55 mm) and half eye frame adapter

120 3286
2894 00N

Technical data

Groove depth:	0 to 0.7 mm
Groove width:	0.55 mm
Thickness of lenses:	(min.) 1.5 to (max.) 11 mm
Lens dia.:	(min.) 25 to (max.) 70 mm
Grooving time:	approx. 40 sec./lens
Power:	57 W
Power usage per 10 min.:	0.0095 kWh
Voltage:	230 V
Size (w x h x d):	170 x 160 x 210 mm
Weight:	2.7 kg

36 month warranty!

 For spare parts contact your local distributor.

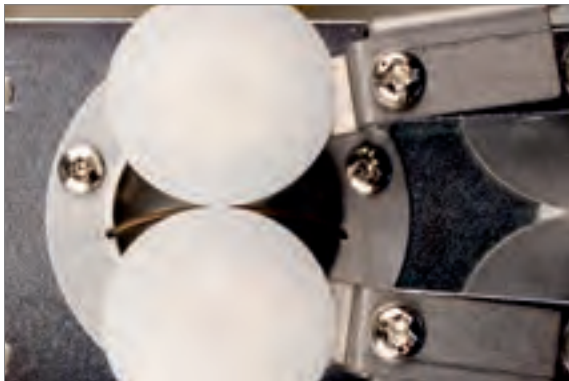

Large, especially supported guide rollers enable grooving of even difficult shapes



Durable ball bearing due to splash water protection



Soft silicone chuck pads ensure a secure grip of the lenses and an even distribution of pressure when clamping them



Both lens guides are fitted with plastic rollers each of which can be finely adjusted to ensure the precise position above the grooving wheel

Spare Parts for Groover No. 120 3286 and 2894 00 (discontinued)

For 120 3286 2894 00N	For 2894 00	Description
120 3273 2893 05N	120 3272 2893 05	Cover for grinding wheel 0.55 mm
120 3274 2893 06	120 3274 2893 06	Driving belt for grinding wheel
120 3275 2893 09	120 3275 2893 09	Guiding pins
120 3276 2893 10	120 3276 2893 10	Ball bearing for diamond wheel shaft
120 3277 2893 13	120 3277 2893 13	Centering pin
120 3278 2893 14	120 3278 2893 14	Soft silicone chuck pads
120 3279 2893 15	120 3279 2893 15	Half eye adapter, small
120 3285 2893 26	120 3285 2893 26	Spare rubber for half eye adapter
120 3293 2894 04N	120 3292 2894 04	Cover for grinding wheel 1.20 mm
120 3295 2894 06	120 3295 2894 06	Chuck knob right
120 3302 2894 29	120 3302 2894 29	Screw for diamond wheel
–	120 3317 2894 43	Plastic knob, right, old version with serial number 279 72 and older
120 3319 2894 51N	–	Guide roller, holder and lever left and right
120 3321 2894 52N	120 3320 2894 52	Guide roller, holder and lever left complete
120 3323 2894 53N	120 3322 2894 53	Guide roller, holder and lever right complete
120 3325 2894 54N	120 3324 2894 54	Guide roller & holder left
120 3327 2894 55N	120 3326 2894 55	Guide roller & holder right

Lens Groover

- Large guide rollers enable grooving of even difficult lens shapes
- Adjustable groove depth
- Grooving parallel to rear face possible
- 4 different grooving types to choose from:
 - Controlled grooving parallel to front or back surface
 - Free wheel grooving
 - Manual controlled grooving
- No adaption on lens curvature necessary
- Including standard groove wheels No. 109 6899 (0.55 mm)

120 3373
2899 00N



Technical data

Groove depth:	0 to 0.7 mm
Groove width:	0.55 mm
Thickness of lenses:	1.5 to max. 11 mm
Min. lens size for a rectangular flat shape with rounded corners:	22 x 56 mm
Grooving time:	approx. 40 sec/lens
Power:	100 W
Power usage per 10 min:	0.0167 kWh
Voltage:	220 V
Size (w x h x d):	170 x 152 x 220 mm
Weight:	2.9 kg

 **36 month warranty!**

 For **spare parts** contact your local distributor.



Spare Parts for Groover No. 120 3373 and 2899 00 (discontinued)

For 120 3373 2899 00N	For 2899 00	Description
120 3351 2898 13	120 3351 2898 13	Chuck knob right with lock screw
120 3352 2898 14	120 3352 2898 14	Right shaft assembly
120 3361 2898 23	120 3361 2898 23	Ball bearing for driveshaft
120 3362 2898 24	120 3362 2898 24	Drive belt for grooving motor
120 3379 2899 01N	120 3378 2899 01	Groove table complete
120 3382 2899 03N	120 3381 2899 03	Cover for diamond wheel 0.55 mm
120 3388 2899 10N	–	Cover for diamond wheel 1.05 mm/1.20 mm
120 3390 2899 19N	–	Left guide roller
120 3391 2899 20N	–	Right guide roller



Consumables and Accessories for Lens Groovers

Details of the differences:

The grooving wheels made in France offer a very long tool life due to a special sintered diamond coating. The centred axis support guarantees a precise rotation. With this equipment the B&S lens groover will do a perfect job for you.

A worthwhile investment.



Diamond Grooving Wheel

- Especially for polycarbonate, with notches
- For groove wide: 0.55 mm
- Outer diameter: 25 mm
- For No. 2894 00, 120 3286, 2899 00 and 120 3373



120 3331
2894 58

- For groove wide: 0.55 mm
- Outer diameter: 25 mm
- For No. 2894 00, 120 3286, 2899 00 and 120 3373



120 3269
2893 01

- For groove wide: 1.05 mm
- Outer diameter: 25 mm
- For No. 2894 00, 120 3286, 2899 00 and 120 3373



120 3281
2893 18

- For groove wide: 1.23 mm
- Outer diameter: 25 mm
- For No. 2894 00, 120 3286, 2899 00 and 120 3373



120 3291
2894 03

Diamond Grooving Wheel

- For groove wide: 0.55 mm
- Outer diameter: 25 mm
- For No. 2894 00, 120 3286, 2899 00 and 120 3373



109 6899
2898 33

Half-Eye Frames Adapter

- For No. 2894 00 and 120 3286



120 3279
2893 15  1 pair

Adapter Set for Lenti Grooving for No. 120 3286

- Consists of diamond wheel No. 120 3283 and support table No. 120 3284
- Possible rim reduction: 2 mm
- For No. 2894 00 and 120 3286



120 3282
2893 20  230 g

Diamond Wheel

- For lenti grooving
- Spare part for adapter set No. 120 3282



120 3283
2893 21

Hand Edger

- Available with 2 different diamond wheels
- Compact and robust plastic housing
- Switch to change the direction of rotation
- 35 mm width diamond wheel with V-bevel

Rough and fine surfaces with V-bevel

120 3704
2928 00

With fine surfaces with V-bevel

121 1531
2928 20



Technical data	
Speed:	2,000 rpm
Measurement of diamond wheel:	Ø 100 mm, width 35 mm
Thickness of graining layer:	2 mm
Power:	150 W
Power usage per 10 min:	0.0249 kWh
Voltage:	220–240 V
Size (w x h x d):	225 x 275 x 360 mm
Weight:	7.5 kg

 **12 month warranty!**

 For **spare parts** contact your local distributor.

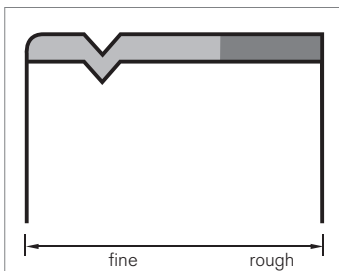

120 3704
2928 00

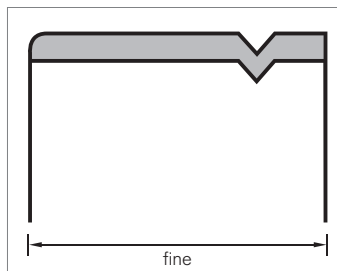

121 1531
2928 20

Hand Edger with Sensor

- Rough and fine surfaces with V-bevel
- Contact free operation through an **infra-red sensor**
- Compact and robust plastic housing
- Switch to change the direction of rotation
- 35 mm width diamond wheel with V-bevel

120 3714
2928 10



Technical data	
Speed:	2,000 rpm
Measurement of diamond wheel:	Ø 100 mm, width 35 mm
Thickness of graining layer:	2 mm
Power:	150 W
Power usage per 10 min:	0.0249 kWh
Voltage:	220–240 V
Size (w x h x d):	225 x 175 x 360 mm
Weight:	7.5 kg

 **12 month warranty!**

 For **spare parts** contact your local distributor.

Chamfering Unit with V-Facet

- Fine surface with V-bevel
- Compact and robust plastic housing
- Switch to change the direction of rotation
- 34 mm width diamond wheel with V-bevel

120 3698
2927 10



Technical data	
Speed:	2,800 rpm
Measurement of diamond wheel:	Ø 100 mm, width 34 mm
Thickness of graining layer:	2.5 mm
Power:	75 W
Power usage per 10 min:	0.0125 kWh
Voltage:	220–240 V
Size (w x h x d):	180 x 180 x 260 mm
Weight:	5 kg

 **12 month warranty!**

 For **spare parts** contact your local distributor.



The original made in Japan

The classic hand edger with long durability and especially high graining layer thickness. The high-quality diamond wheels are manufactured with precision to ensure a uniform smoothness. A reliable helper in your workshop!

TAKUBOMATIC Hand Edger in 2 Versions

- Direction switch to change the direction of rotation
- High quality diamond wheel, 30 mm width, available in different versions, especially long lasting



Diamond Hand Edger

With diamond wheel
Finishing wheel with V-bevel and shoulder

120 3692
2923 00

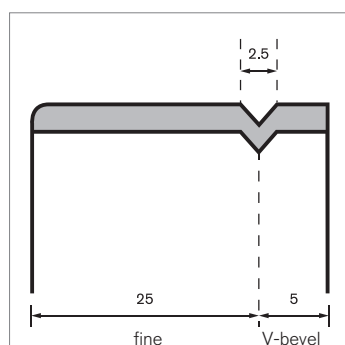

Diamond Hand Edger

With diamond wheel
With V-bevel, rough and fine surfaces

120 3693
2925 00

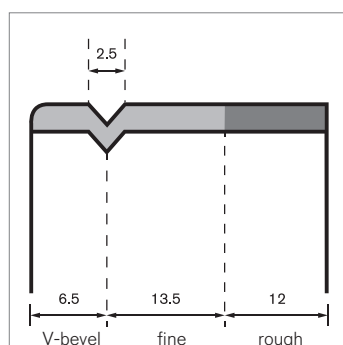

Technical data

Speed:	1,800 rpm
Measurement of diamond wheel:	Ø 100 mm, width from 30 to 32 mm
Thickness of graining layer:	1.2 mm
Power:	97 W
Power usage per 10 min:	0.0162 kW
Voltage:	230 V
Size (w x h x d):	220 x 280 x 360 mm
Weight:	8 kg

36 month warranty!

For **spare parts** contact your local distributor.

The “work horse” in a new design

We searched for a long time before we found this polishing motor “Made in Germany” which meets all our requirements: strong torque and variable speed control during clockwise and anti-clockwise rotation. Special features: low speed for easy polishing of delicate materials such as polycarbonate. An optional flexible shaft extends the range of applications. You can rely on this all-rounder made in Germany if you want to polish efficiently and effectively.



B & S Polishing Motor with Clockwise and Anti-clockwise Rotation

- Frequency-controlled three-phase motor
- Clockwise and Anti-clockwise rotation
- Low maintenance ball bearings
- Low noise
- 300 W
- Designed for continuous operation
- Including left and right polishing tip

120 3772
2967 00

Technical data

Speed:	0 up to 6,000 rpm (variable speed)
Height of spindle:	111 mm
Power:	300 W
Power usage per 10 min:	0.0499 kWh
Voltage:	230 V
Size (w x h x d):	250 x 170 x 172 mm
Weight:	11 kg

36 month warranty!

For **spare parts** contact your local distributor.



Spare Tips for the Polishing Machines No. 120 3772 and 2966 00 (discontinued)

Polishing Tip, left

With right hand thread.

120 3769
2966 22

∅ 14 mm (Bore)

—|— approx. 115 mm



Polishing Tip, right

With left hand thread.

120 3770
2966 23

∅ 10 mm (Bore)

—|— approx. 115 mm



Please consider before ordering: **Lever in right hand run position (clockwise wheel rotation):**
left: polishing tip No. 120 3769 – right: polishing tip No. 120 3770

LUX Polishing Motor

- With two conical tips (right/left thread) and one wheel adapter
- Two different speed settings
- Not designed for continuous use (max. 20 min)

120 3782
2968 00



Technical data

Speed:	1,400 and 2,800 rpm
Power:	300 W
Power usage per 10 min:	0.0499 kWh
Voltage:	230 V
Size (w x h x d):	250 x 300 x 150 mm
Weight:	5.5 kg

36 month warranty!

For **spare parts** contact your local distributor.



You will find our buffing wheels and polishing wax on page E 27.

Universal Dust Collector for right and left

- Metal casing with removable plastic tray

120 3787
2968 20

Technical data

Size (w x h x d):	185 x 280 x 270 mm
Weight:	2.75 kg



Automatic Drilling Machine

For drilling and milling

- Easy and quick capture of the drill hole coordinates by using the previous lenses or demo lenses
- Memorises drill hole coordinates of the current scanned frame
- **The saved drill holes will be automatically approached one by one, the drilling process is fully automatic for all drill holes**
- Good drilling results in a very short time

Accessories included:

- Marking aid for lenses No. 120 3251
- Drills (1.0; 1.2; 1.4; 1.5; 1.6; 1.7; 2.0)
- Millers (0.8; 1.1; 1.2; 1.4)
- Drill-miller set No. 120 2547

120 3259

2890 30



Technical data

Speed:	0 up to 3,000 rpm
Power:	50 W
Power usage per 10 min:	0.0083 kWh
Voltage:	230 V
Size (w x h x d):	300 x 225 x 270 mm
Weight:	5 kg

 **12 month warranty!**

 For **spare parts** contact your local distributor.

Marking Set

120 3251

2889 01





LessStress Drilling Machine

- LessStress drills and mills each lens exactly (0.05 mm with digital display of both axes) according to support lens or drawing
- Drill head swivels

Accessories included:

- LessStress Drilling Machine
- 2 working plates
- 3 carbide milling drills (1.2; 1.3; 1.4)
- Phillips screwdriver
- Collet with collet set
- 4 PVC supports, 2 PVC strips
- 6 clamping straps for blocked-off glasses
- 2 clamping straps for blocked glasses
- 1 zero setter, 2 drive belts, 2 clamping bridges
- storage block for drills
- Power supply 230–12 V
- Operating instructions

120 3229

2884 00

Technical data

Speed:	2,400/3,600/4,800 rpm
Power:	12 W
Power usage per 10 min:	0.00199 kWh
Voltage:	230 V
Operating voltage:	12 V
Size (w x h x d):	300 x 300 x 220 mm
Weight:	3.2 kg

 **12 month warranty!**

 For **spare parts** contact your local distributor.



You will find our drills and millers from page C 32 on.

Drilling Centre

Drilling, milling and grooving – all demands for stylish rimless frames are easily met with this very reasonably priced drilling centre.

- Drill, mill and groove accurately with both lenses blocked side by side
- Can be used on a stand or as a hand drill
- Compact easy to use cross table
- Storage for drills, millers and small parts
- Cross table with millimeter scale, separately available: No. 120 2672
- Lens angle changeable to minimise adjustments after frame assembly
- Inclination adjustable through dial

120 2671
2191 06

Including WECO blocker Take-up (can also be used without blockers)





Lens Drilling Device for NIDEK Toothed Blocks (without illustration)

Suitable for Xenox and Proxxon cross tables.
Complete with NIDEK blocker Take-up.

120 3263
2891 64-NIDEK

Technical data	
Speed:	5,000 to 20,000 rpm (adjustable)
Chuck:	0.5 to 3.2 mm
Cross table surface:	200 x 70 mm
Adjusting range for cross table:	X (diagonal) 134 mm, Y (deep) 46 mm
Power:	60 W
Power usage per 10 min:	0.0099 kWh
Voltage:	230 V
Operating voltage:	12 V
Size without transformer (w x h x d):	280 x 400 x 330 mm
Weight:	2.8 kg

 **36 month warranty!**

 For **spare parts** contact your local distributor.



 For **blocker Take-up and spare parts** contact your local distributor.



Xenox Table Drilling Machine

- Precision measurements due to depth perceptions scale
- Fixed knob with scale
- Transmission belt drive
- Very quiet running
- Incl. machine vice No. 120 3243
- Incl. drill chuck No. 120 3237
- 6 steel clamps for shaft size from 0.8 to 3.2 mm
- **Accessories:** Base plate No. 120 3239, cross table No. 120 2672 and lens rest dome No. 120 2676

120 3248
2887 55

Identical with No. 120 3248, however **without** accessories.

120 3242
2887 20



Technical data	
Speed:	1,800 and 4,700 and 8,500 rpm (change by adjusting the belt)
Power:	85 W
Power usage per 10 min:	0,0142 kWh
Voltage:	230 V
Size (w x h x d):	120 x 330 x 220 mm
Weight:	5,7 kg

36 month warranty!

For **spare parts** contact your local distributor.



Practical drill depth indication
with adjustable knob

Proxxon Drilling Stand

- Cantilever head can be swivelled up to 90°, enabling oblique drilling and versatile milling
- Sensitive feed through steering wheel and roller bearings
- Solid, chrome steel pillar (Ø 20 mm, 280 mm long)
- The handpiece collet can be tilted to both sides in 90°
- Weight: 2 kg

Drilling machine No. 120 3233 and vice No. 120 3243
are not included.

120 2653
2128 65

36 month warranty!

For **spare parts** contact your local distributor.



Machine Vice

For table drilling machine No. 120 3242 and drill stand No. 120 2653
and 2128 70 (discontinued).

120 3243
2887 21



Xenox Drilling and Milling Unit

Incl. 6 chucks with 1.0; 1.5; 2.0; 2.4; 3.0 and 3.2 mm diameter and drill chuck No. 120 3234.

Does not include pictured grinding wheels or polishing wheels.

120 3233
2886 61



Technical data	
Speed:	5,000 to 20,000 rpm
Power:	60 W
Power usage per 10 min:	0.0099 kWh
Voltage:	230 V
Size (w x h x d):	240 x 90 x 240 mm
Weight:	2.9 kg

36 month warranty!

For spare parts contact your local distributor.

Proxxon Hand Drilling Machine with Transformer

Incl. 6 chucks with 1.0; 1.5; 2.0; 2.4; 3.0 and 3.2 mm diameter.

120 3232
2886 60



Technical data	
Speed:	5,000 to 20,000 rpm (adjustable)
Power:	60 W
Power usage per 10 min:	0.0099 kWh
Voltage:	230 V
Size (w x h x d):	140 x 80 x 240 mm
Weight:	2.9 kg

36 month warranty!

For spare parts contact your local distributor.



You will find our small tools from page C 31 on.



Hot quality

The AQUARIUS Hydrozon soldering unit is manufactured by a small company in Germany under full compliance with the most demanding quality standards. The best unit we have found. Hydrozon soldering technology minimises harmful oxidation during the soldering process and offers a material saving repair. The environmentally-friendly technology can be used for years almost without the need for any consumables, making it very cost-effective in the long term. We guarantee repair and spare parts service for many years.



AQUARIUS Welding and Soldering Unit

- Designed for continuous use
- Safety pressure control function and backfire control valve built into the handpiece and the hose connection
- Precise regulation of flame is possible by using different size jets and a small knurling wheel
- Optical display of push button function via LED
- Integrated flux container
- **Accessories included (1 each):**
Holder for soldering hand piece No. 120 3108, soldering hand piece No. 120 3109, float levels No. 120 3111 and 120 3112, electrolyte No. 120 3958 and flux No. 120 3960

120 3092
2839 60

AQUARIUS Welding and Soldering Unit

- Like No. 120 3092, but with max. gas power of 50 l/h
- 2 workstations may be run simultaneously
- **Accessories included (1 each):**
Holder for soldering hand piece No. 120 3108, soldering hand piece No. 120 3109, float levels No. 120 3111 and 120 3112, sets of jets No. 120 3105, electrolyte No. 120 3958 and flux No. 120 3960

120 3087
2839 00

Technical data	120 3092 2839 60	120 3087 2839 00
Number of possible workstations:	1	2
Maximum gas capacity:	45 l/h	50 l/h
Water consumption:	16 g/h	28 g/h
Flux consumption:	6 g/h	8 g/h
Biggest applicable jet:	20 G (0.9 mm)	19 G (1.0 mm)
Power:	200 W	250 W
Power usage per 10 min:	0.0333 kWh	0.0417 kWh
Voltage:	230 V	230 V
Size of machine without attachments (w x h x d):	450 x 280 x 220 mm	450 x 280 x 220 mm
Operation weight:	14 kg	17 kg

42 month warranty and 20 years spare parts warranty!

For **spare parts** contact your local distributor.

Micro-Torch II+ Complete Set with Central Dosing Valve

- Practical soldering device, efficient and space saving
- With central dosing valve for flame regulation that greatly reduces oxygen and gas consumption
- **Accessories included:**
- 2 oxygen bottles No. 120 3072, hand piece No. 120 3073, gas cartridge No. 120 3075, Triox adapter with dosing valve No. 120 3080 and single jets No. 120 3098, 120 3100, 120 3102 and 120 3103

120 3077
2762 05

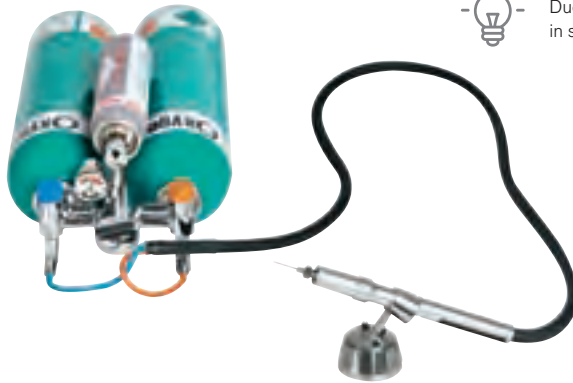

For **spare parts** contact your local distributor.



Due to legal requirements gas and oxygen will be delivered in separate packaging.

Micro Soldering Unit, Type B.P.

- Small and handy unit
- Piezo ignition
- Special jet with air supply provides a small, pointed and 1,600 °C hot flame
- Ready for use, delivery with 1 bottle No. 120 3075

120 3081  160 g
2763 00



Soldering Iron

- Nickel-plated copper tip, straight pointed
- Including hand piece rest

120 3082  200 g
2770 00



Technical data

Power:	25 W
Power usage per 10 min:	0,0042 kWh
Voltage:	230 V
Temperature:	max. 420 °C
Heating time:	2 min
Connector cable:	1.5 m
Diameter:	4 mm

For **spare parts** contact your local distributor.

Punch with Grooved Head for Use in No. 120 3082:

120 3083 **Punch with grooved head** Inside width: 3 mm
2770 10



120 3084 **Punch with grooved head** Inside width: 1.8 mm
2770 11





The classic “Made in Germany”

Reliable for decades and almost unchanged. A solid help with a steady hand.

Soldering Station

- Ideal for holding broken spectacle frames when soldering
- Two adjustable clamps, vertically and horizontally movable
- Mounting of a “Third Hand” possible
- Baseplate heat resistant
- Size of baseplate (w x d): 295 x 210 mm

120 3058
2757 00

 2.1 kg

 For **spare parts** contact your local distributor.



Soldering Station with small Base Plate

- Ideal for fixing workpieces
- With 3 adjustable clamps
- Clamps vertically and horizontally adjustable and lockable
- Small space-saving base plate
- Fixing facility for one additional clamp on the base plate
- Material: chromed brass and stainless steel
- Dimensions of the base plate (w x d): 100 x 100 mm

120 3068
2757 20

 1.4 kg

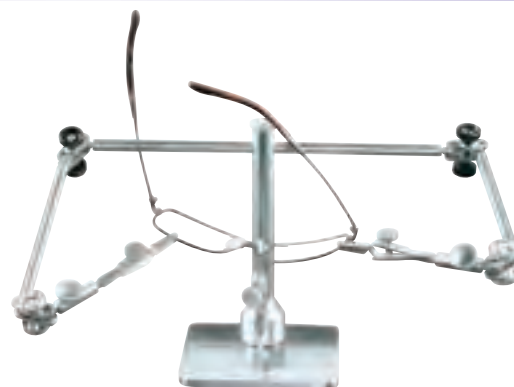

Accessories for the Soldering Unit No. 120 3077 for AQUARIUS Soldering and Welding Units

Single Jets

Gauge* Description	Jet Ø	Opening Ø	Order No.
24	0.5 mm	4.0 mm	120 3097 2840 05
23	0.6 mm	4.0 mm	120 3098 2840 06
22	0.7 mm	4.0 mm	120 3099 2840 07
21	0.8 mm	4.0 mm	120 3100 2840 08
20	0.9 mm	4.0 mm	120 3101 2840 09
19	1.0 mm	4.0 mm	120 3102 2840 10
18	1.2 mm	4.0 mm	120 3103 2840 13

* Gauge refers to a unit of measurement which is used to measure the size of small tubes. The higher the gauge the smaller is the external diameter of the small tube.



Set of Jets

5 pieces assorted.
Jet dia.: 0.6; 0.7; 0.8; 0.9 and 1.0 mm

120 3105
2840 50



You will find our soldering accessoires
on page E 34 to E 37.

Reamers for Jets

With plastic handle, for cleaning of blocked jets.
Reamers-Ø: 0.05; 0.08; 0.10; 0.15; 0.20; 0.25; 0.30; 0.35; 0.40; 0.45;
0.50 and 0.55 mm

120 3104  12 = 1 set
2840 20



The B & S polariscope

"Made in Germany" quality. Its outstanding characteristics are ease of use and functional reliability. The tilted alignment of the polarisation filter makes identifying the stress fields in the lens area both simple and easy. A large test area and good ergonomic qualities make it an optimum aid in the workshop and in the sales area.

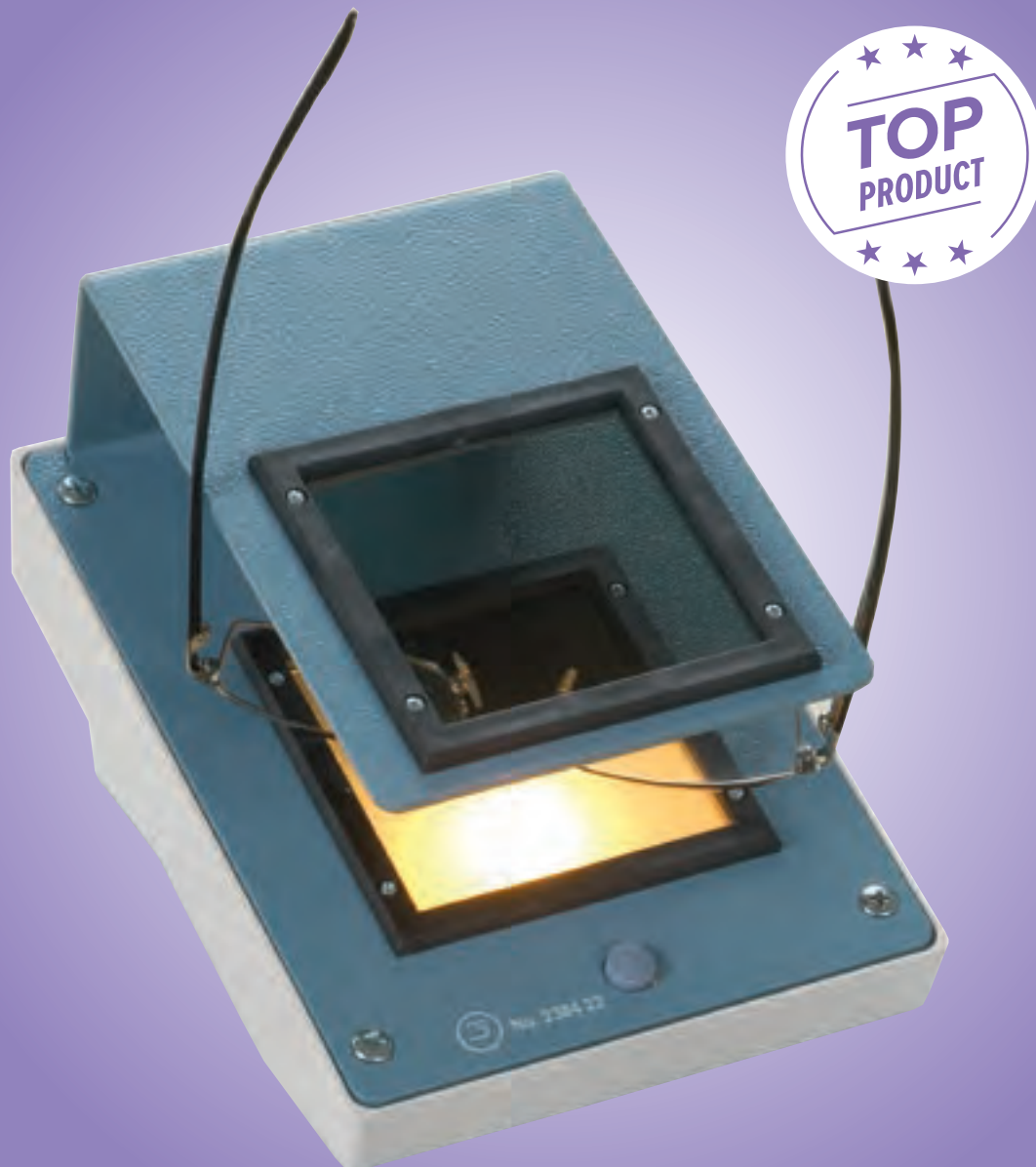

Polariscope

- Now with LED light source
- With illumination via push-button
- Automatic shut-off after approx. 15 sec

120 2862
2384 22

LED Light Source

For No. 120 2862.

120 2865
2384 56

Technical data

Size of test area:	68 x 68 mm
Distance between polarised fields:	50 mm
Timer:	approx. 15 sec illumination
Power:	1.3 W
Power usage per 10 min:	0.0002 kWh
Voltage:	230 V
Size (w x h x d):	130 x 130 x 175 mm
Weight:	700 g

36 month warranty!

 For **spare parts** contact your local distributor.



GFC Polariscope with Adjustable Inclination of the Unit

- Comfortable use because of adjustable inclination of the unit
- Suitable for spectacles with high lens curves
- Extra large distance between the test fields
- With lighting inside the metal housing

120 2881
2397 22

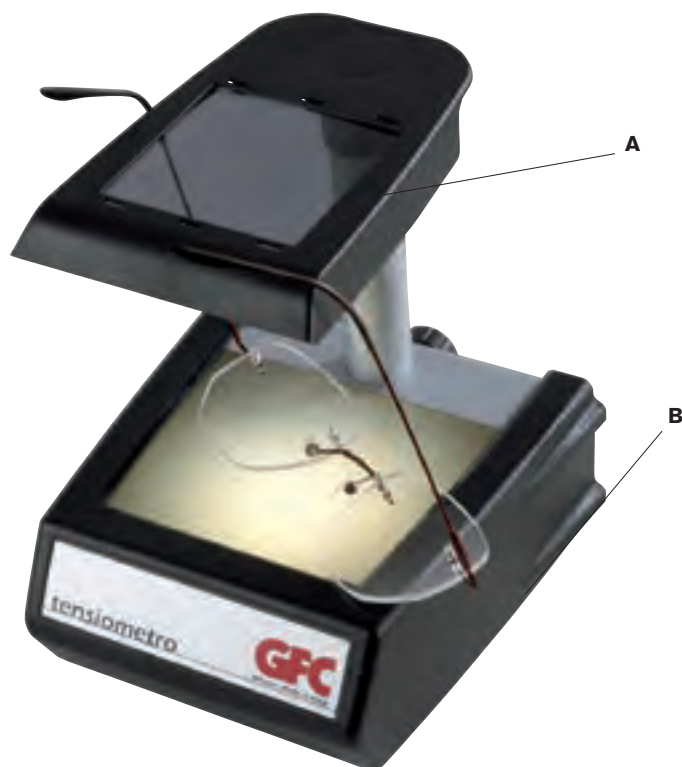

Technical data	
Size of polarising field:	A) 58 x 58 mm B) 75 x 75 mm
Distance between polarised fields:	95 mm
Power:	6 W
Power usage per 10 min:	0.0009 kWh
Voltage:	230 V
Size (w x h x d):	135 x 165 x 150 mm
Weight:	700 g

 **36 month warranty!**

 For **spare parts** contact your local distributor.



Hand Polariscope

With power saving LED, battery, made of plastic and metal.

120 2879
2393 20



Technical data	
Size of polarising field:	40 x 40 mm
Distance between polarised fields:	25 mm
Voltage supply:	9 V battery (type PP3)
Size (w x h x d):	100 x 55 x 48 mm
Weight:	180 g

 **36 month warranty!**

 For **spare parts** contact your local distributor.

GFC UV Test Lamp

To demonstrate photochromatic lenses to customers.

120 2885
2399 00

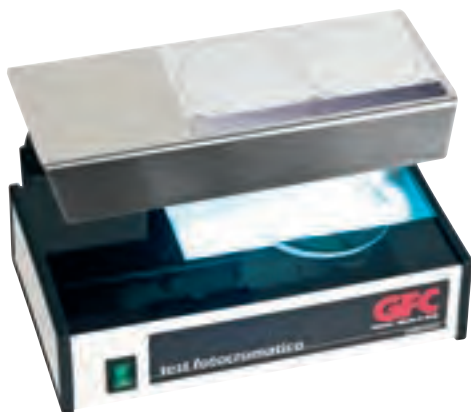

Technical data	
Fuse:	0.5 A
Power:	9 W
Power usage per 10 min:	0.0014 kWh
Voltage:	230 V
Size (w x h x d):	220 x 125 x 120 mm
Weight:	1.75 kg

36 month warranty!

For **spare parts** contact your local distributor.

Transmittance Measuring Device

For measuring the transmission of spectacle lenses in the UV-light, visible and infrared light range. Quick and simple measurement.

120 2892
2412 00

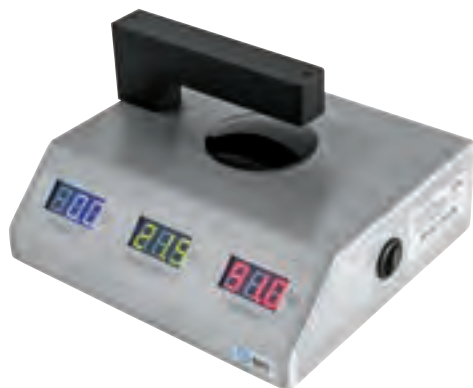

Technical data	
Measurement range UV:	365 nm
Measurement range VIS:	380–760 nm
Measurement range IR:	950 nm
Measurement tolerance:	+/- 2%
Voltage:	230V / 50Hz AC
Size (w x h x d):	200 x 106 x 180 mm
Weight:	1.5 kg

12 month warranty!

For **spare parts** contact your local distributor.

GFC Progressive Marking Reader

- To easily identify progressive markings on the back and front surface of lenses
- Comfortable to use because of adjustable inclination of the unit (75 x 75 mm)
- Suitable for spectacles with high lens curve

120 2900
2451 00



Technical data	
Power:	6 W
Voltage:	230 V
Size (w x h x d):	135 x 270 x 150 mm
Weight:	1.2 kg

36 month warranty!

For **spare parts** contact your local distributor.



Hygiene Box

- Absolutely reliable – disinfection of up to 99.9% of all microorganisms
- Extremely quick application – only 30–60 seconds for disinfection
- Environmentally friendly – sustainable and chemical free UV-C disinfection without waste
- Zero resistance
- Completely dry, no liquid or any other additives required
- Lifetime of UV-C lamp approx. 9,000 hrs (equals about 8.2 years with an average use of 3 hrs/day)
- Low maintenance and easy handling
- Very little after sales costs (only for current and a possible lamp exchange after years)
- Holds up to six frames in parallel

120 2903
2471 00



Technical data	
Duration of an application:	30–60 seconds
Wavelength:	253.7 nm
Power:	8 W
Power usage per 10 min:	0.0013 kWh
Lamp mean lifetime:	9,000 h
Voltage:	230 V 50 Hz
Size (w x h x d):	340 x 210 x 190 mm
Weight:	3.8 kg



36 month warranty!

For **spare parts** contact your local distributor.

Tray for GFC UV sterilizer

- Tray for 120 2903
- Enables the cleaning of smaller items, such as trial lenses or screwdrivers

120 2906
2471 03

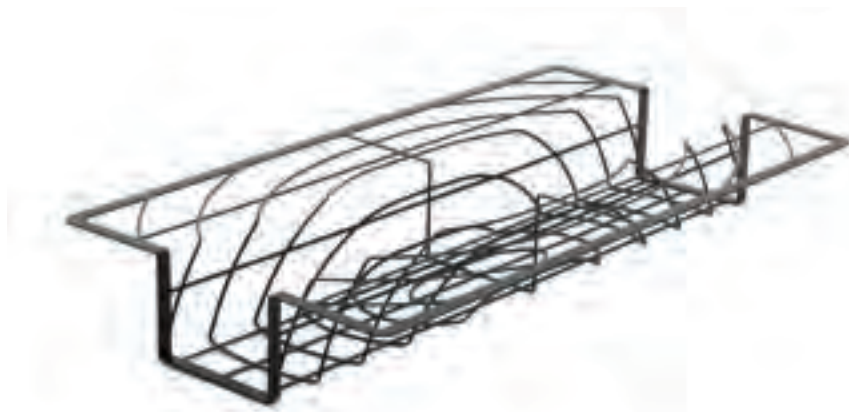

UV Lamps for UV Light Curing Adhesives

- To activate all UV curing glues
- UV protection for the user
- Continuous operation and time setting 120 sec (with No. 120 2896)
- No. 120 2896 with extendable worktop
- Large exposure field
- No. 120 2894 with 15 energy-efficient LED lamps
- No. 120 2894 with time setting 99 sec and infrared sensor

Technical data	120 2896 2431 00	120 2894 2421 00
Power:	36 W (4 x 9 W)	24 W
Power usage per 10 min:	0.0059 kWh	0.0039 kWh
Voltage:	230 V	230 V
Size (w x h x d):	220 x 75 x 120 mm	215 x 75 x 120 mm
Weight:	900 g	200 g

120 2896
2431 00

120 2894
2421 00

 24 month warranty!



120 2896
2431 00

120 3945
3184 10



120 2894
2421 00

120 3940
3184 03

Bulb for the UV Lamp for Adhesives

Spare bulb for No. 2430 00*, 2420 00*, 2420 10*, 121 0377 and 120 2896.
Capacity: 9 W

120 2898
2431 01



LED Bulb for the UV Lamp for Adhesives

Spare bulb for No. 2430 00*, 2420 00*, 2420 10*, 121 0377 and 120 2896.
Capacity: 9 W

120 2899
2431 02



You will find our UV-Fix-Gel on page E 11.

* discontinued



Tinting Unit Tinta 2 for 2 Pots

- This unit is designed to heat tinting solutions to dye uncoated organic lenses
- With adjustable temperature and clock timer
- Perfect to use with B&S dye powder No. 120 3009–120 3028
- Including 2 stainless steel pots and one stainless steel lens holder

120 3226
2880 01

Technical data

Power:	max. 1,035 W
Power usage per 10 min:	0.1724 kWh
Voltage:	230 V
Size (w x h x d):	160 x 220 x 430 mm
Weight:	4.2 kg

 **36 month warranty!**

 For **spare parts** contact your local distributor.



You will find dyes for the tinting unit on page E 20.

The B & S CLAVULUS, proven quality from Germany

The CLAVULUS has been produced exclusively for B & S by more than three generations of the same precision engineering company in the Black Forest. With this classic piece of equipment many tasks which involve spectacles can still be carried out simply and dependably. The craft precision used in its manufacture and our satisfied users have kept the CLAVULUS in the B & S product range for almost 75 years.

A comprehensive range of accessories extends the scope of the applications which it can be used for. Opticians for whom craftsmanship is the focus of attention will especially appreciate its qualities.



CLAVULUS

- For quick and easy repairs
- **Special accessories:** Peening punch, riveting punch, flaring punch 1.5 mm, rivet puller, punch for spread hinges, single punch, double punch and 7 anvils

The Original with

 30 years warranty!

 For spare parts contact your local distributor.

130 1038
2125 50

 135 x 290 x 175 mm

 2.5 kg



Accessories for CLAVULUS

Bending Device for Bridge Narrowing

With wide and narrow cone.

120 2627
2125 26



Fixing Screw for Punches and Anvils

120 2664
2147 00



Lens Drilling Device

- A lockable precision micrometer screw ensures the correct distance between edge of lens and bore hole centre
- Two pivots allow perfect centering for drilling

120 2654
2129 00



- Incl. drilling support
No. 120 2655



Peening Punch

120 2619
2125 01



Riveting Punch

120 2620
2125 02



Flaring Punch, Ø 1.5 mm

120 2621
2125 04



Flaring Punch, Ø 2.1 mm

120 2622
2125 05



Anvil, Ø 1.8 mm

120 2632
2125 41



Stamp

For marking spectacles
(see also page B 31).

120 2629 2125 31 1 sign



120 2630 2125 32 2 signs

120 2631 2125 33 3 signs





You will find further spare parts
on page A 45.

CLAVULUS

- For quick and easy repairs
- **Special accessories:** Peening punch, riveting punch, flaring punch 1.5 mm, flaring punch 2.1 mm, rivet extractor, double rivet extractor, punch for spread hinges, single punch, double punch, anvil extension and 9 anvils

120 2634
2126 00

 165 x 210 x 265 mm

 3,3 kg

 **24** month warranty!

 For **spare parts** contact your local distributor.





Accessories for CLAVULUS

Suitable for No. 120 2634 and 120 2633.

Peening Punch

120 2635
2126 10



Riveting Punch

120 2636
2126 11



Flaring Punch, Ø 1.5 mm

120 2637
2126 12



Flaring Punch, Ø 2.1 mm

120 2638
2126 13



Rivet Extractor

120 2639
2126 14



Double Rivet Extractor

120 2640
2126 15



Punch for Spread Hinges

120 2641
2126 16



Single Punch

120 2642
2126 17



Double Punch

120 2643
2126 18



Anvil with Slot

120 2644
2126 20



Riveting Anvil

120 2645
2126 21



Anvil without Hole

120 2646
2126 22



Single Hole Anvil

120 2647
2126 23



Anvil Extension

120 2648
2126 25



Plastic Anvil

120 2649
2126 27



Slotted Anvil

120 2650
2126 28



Anvil with Drill, Ø 1.8 mm

120 2651
2126 29



Spare Pins for Single and Double Hole Anvil

120 2652
2126 30  10 pieces







PLIERS

with pliers every grasp fits



- B 2 Parallel Pliers
- B 4 Overview: eLite-, Standard Pliers
- B 6 Inclination Pliers
- B 8 Holding Pliers
- B 10 Nylon Eyewire Pliers
- B 12 Tips & Tricks: Bending Pliers
- B 16 Flat Snipe Nose Pliers
- B 19 Size Testing Pliers
- B 20 Nose Pad Adjusting Pliers
- B 22 Tips & Tricks: Rimless Frame Pliers
- B 25 Special Front Cutters & -Pliers
- B 30 Tips & Tricks: Bionic Thumb
- B 33 Peening Pliers
- B 34 Lens Aligners
- B 36 De-Blocking Pliers
- B 38 Marking Pliers
- B 39 Side & Front Cutter
- B 43 Tips & Tricks: Spring Hinge Pliers
- B 45 Storage for Pliers
- B 46 Handle Cover for Pliers

Parallel Pliers – an innovation at B & S

- **Parallel jaws**
Secure grip due to a parallel jaws position in every situation.
- **Long pliers handles**
Optimum leverage with minimum use of force.
- **Plastic jaws “Made in Germany”**
Naturally the highest quality plastic jaws for extra durability.



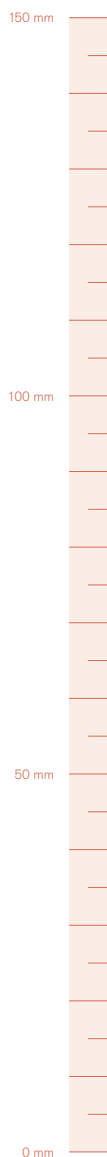

Parallel Holding Pliers 8 mm

With two plastic jaws.
Self-opening by spring mechanism.

120 2020
1551 00P

140 mm  135 g

Replacement plastic jaws:

108 1417
1551 01

 1 pair

Parallel Pressure Mount Pliers

For pressing in the plastic sleeves on rimless frames of type Silhouette "Minimal Art" or similar models.
Self-opening by spring mechanism.

120 1907
1511 00P

140 mm  140 g

Replacement plastic jaws:

120 1909
1511 01

 1 pair

B & S Pliers* – decades of experience in your hand

- **Unique design**

Developed by B & S, functional and protected worldwide.

- **10 years warranty**

(except cutting pliers and eLite spring hinge plier no. 120 1925 and all plastic parts)
Solid and durable.

- **Reliable quality**

Forged joint, precise manufacturing, highly durable plastic jaws.



You will find our Plasti Dip
on page E 22 and E 23.



You will find our practical shrinking tubes
for plier handles on page B 46.





Standard Pliers – proven a million times over

- **Robust design**
Ideal for people who prefer working with heavier tools.
- **Long handles**
For optimum leverage with a minimum use of force.
- **Textured surface**
Provides a safe grip, prevents slipping.

eLite Pliers – the ultra-light alternative

- **Handy size**
Also suitable for smaller hands.
- **Lighter**
Light pliers for less effort.
- **Very secure grip**
Asymmetrical ends and textured grip to prevent slipping.

eLite: smaller, lighter and with matt finish



Inclination Pliers – Conical 8 mm

To adjust metal hinges, one side with nylon jaw, conical jaw: \varnothing 6:1.5 mm.

Standard:

109 2191

1558 00N

150 mm 140 g

eLite:

120 2041

1558 50

148 mm 100 g

Replacement plastic jaw (also for 1558 00 P – discontinued):

109 2205

1558 01



Inclination Pliers – Conical 6 mm

To adjust metal hinges, for **delicate frames**, one side **with extremely thin flat nylon jaw**, conical jaw: \varnothing 6:1.5 mm.

Standard:

109 2192

1558 10N

150 mm 140 g

eLite:

120 2044

1558 55

148 mm 100 g

Replacement plastic jaw:

109 2206

1558 02

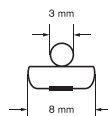

Inclination Pliers – with Notch 8 mm

To adjust thin metal frames,
one side with nylon jaw,
conical jaw: $\varnothing 6:1,5$ mm.

Standard:

120 2039

1558 20N

150 mm

140 g



Inclination Pliers – Cylindrical 8 mm

Especially designed for nylon frames, extremely thin cylindrical
metal pin, other jaw is covered with nylon.

Standard:

109 2193

1596 00N

150 mm

140 g

Replacement plastic jaw (also for 1558 00 P – discontinued):

109 2205

1558 01

Replacement plastic jaw:

109 2207

1596 01

Handle cover for pliers –
your advantage at work from B & S

- Better grip
- Comfortable working



You will find our practical shrinking tubes for pliers handles on page B 46.

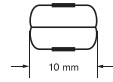

Holding Pliers 10 mm

With plastic jaws, jaw mouth remains in parallel position up to approx. 3 mm.

Standard:
108 0766
1553 00N

150 mm  140 g

Replacement plastic jaws:

108 1418
1553 01

 1 pair



Holding Pliers 8 mm

With plastic jaws.

Standard:

108 0767
1551 00N

150 mm  140 g

eLite:

120 2024
1551 50

148 mm  100 g

Replacement plastic jaws:

108 1417
1551 01

 1 pair



Holding Pliers 6 mm

With plastic jaws, mouth remains in parallel position at a gap of approx. 3 mm.

Standard:

120 2055
1565 00N

150 mm  140 g

eLite:

120 2058
1565 50

148 mm  100 g

Replacement plastic jaws:

120 2057
1565 01

 1 pair



Nylon Eyewire Shaper 24 mm

With plastic jaws, large version.

Standard:

120 1894

1507 00N

150 mm 140 g

eLite:

120 1898

1507 50

145 mm 110 g

Replacement plastic jaws:

120 1896

1507 01

1 pair



Nylon Eyewire Shaper 19 mm

With plastic jaws, small version.

Standard:

120 1900

1509 00N

145 mm 140 g

Replacement plastic jaws:

120 1902

1509 01

1 pair

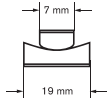



Nylon Eyewire Shaper 19/7

One plastic jaw (19 mm), one plastic jaw (7 mm).
Perfect to adjust bridges.

Standard:

108 0762



1506 00N

 145 mm  140 g

Standard:

120 2104

1584 00N

 145 mm  140 g

eLite:

120 2107

1584 50

 137 mm  100 g

Replacement plastic jaws:

108 1415

1506 01

 1 pair

Replacement plastic jaws:

120 2106

1584 01

 1 pair

TIPS & TRICKS

BENDING PLIERS WITH 3 ROLLERS

One Plier for Many Applications!

Bending Pliers with 3 Rollers

No. 108 0761, 120 2064



approx. 1–2 minutes

This is how it works

TO ADJUST THE:

1 TEMPLES



2 EYEWIRE



3 BRIDGE



4 TEMPLE ENDS



5 LENS SHAPE





Bending Pliers with 3 Rollers

For various purposes: to adjust spectacles, bridges, temples and temple tips.

Standard:

108 0761

1566 00N

150 mm 140 g

eLite:

120 2064

1566 50

148 mm 95 g

Replacement plastic jaws:

108 1413

1566 01

1 set



eLite: smaller, lighter and with matt finish



You will find our Plasti Dip on page E 22 and E 23.



You will find our shrinking tubes on page F 77.

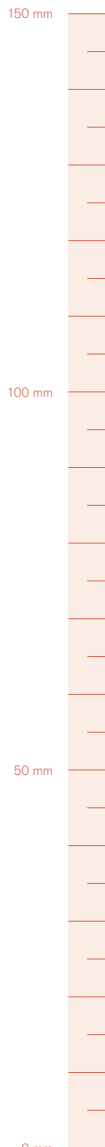
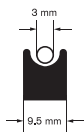

Bending Pliers

Based on the trident pliers concept. This plier is particularly suitable for a careful adjustment of softer materials. The plastic jaw prevents scratches. The thorn can additionally be padded by a shrinking tube or Plasti Dip.

Standard:

120 1994
1544 00N

|—| 140 mm ●▲ 140 g

eLite:

120 1997
1544 50

|—| 137 mm ●▲ 90 g



Trident Pliers

For precise and easy adjustment of clip-on bridges.

Standard:

108 0760
1513 00N

|—| 140 mm ●▲ 140 g

eLite:

120 1923
1513 50

|—| 137 mm ●▲ 100 g

Replacement plastic jaw:

120 1996
1544 01

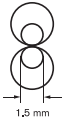

Round Snipe Nose Pliers

Round jaws.

Standard:
120 1882
 1501 00N

| 150 mm ●▲ 140 g

Round Snipe Nose Pliers with Notches

Round jaws.
 Notches in both tips.

Standard:
120 1884
 1501 10N

| 150 mm ●▲ 140 g



Flat Snipe Nose Pliers – Extra Long

Flat inner jaws.
Extra long and thin version.

Standard:

120 2051

1564 00N

—| 155 mm ●▲ 140 g

eLite:

120 2053

1564 50

—| 148 mm ●▲ 100 g



Flat Snipe Nose Pliers

Semi-circular jaws.

Standard:

120 1933

1515 00N

—| 150 mm ●▲ 140 g

eLite:

120 1935

1515 50



—| 148 mm ●▲ 100 g



Flat Semi-circular Snipe Nose Pliers

One round jaw, one semi-circular jaw.



Standard:
120 1941
1517 00N

 150 mm  140 g

Flat Nose Pliers 5 mm

5 mm width at tip.

Standard:
109 2196
1523 00N

 150 mm  140 g

eLite: smaller, lighter and with matt finish



Flat Nose Pliers 3 mm

3 mm width at tip.

Standard:
109 2197
1522 00N

150 mm 140 g

eLite:
120 1953
1522 50

148 mm 95 g



Nose Pad Removing Pliers

For removal of "push-in-type nose pads".

Standard:
120 1886
1502 00N

150 mm 140 g

eLite:
120 1888
1502 50

148 mm 100 g



Size Testing Pliers

For testing lens size during the finishing process.

Standard:

109 2194

1542 00N

|—| 145 mm

●▲ 140 g

eLite:

120 1992

1542 50

|—| 139 mm

●▲ 95 g



Size Testing Pliers – Large

For testing lens size during finishing process, with extra large mouth.

Standard:

120 1970

1531 00N

|—| 155 mm

●▲ 140 g

eLite:

120 1972

1531 50

|—| 145 mm

●▲ 90 g

Handle cover for pliers –
your advantage at work from B & S

- Better grip
- Comfortable working



You will find our practical shrinking tubes for pliers handles on page B 46.



Nose Pad Adjusting Pliers – Universal

Perfect for adjusting click, screw or Primadonna pads.

Standard:

120 2014

1550 10N

—| 150 mm

▲ 155 g

eLite:

120 2016

1550 55

—| 148 mm

▲ 120 g



Nose Pad Adjusting Pliers – Push-in Nose Pads

Especially for fitting push-in nose pads. Very delicate version to avoid touching the lens during fitting.

Standard:
120 2010
 1549 00N

 150 mm  140 g

eLite:
120 2012
 1549 50



 147 mm  95 g



Nose Pad Adjusting Pliers – Screw-in Nose Pads

For screw-in nose pads. Improved, a more delicate version to avoid touching the lens during fitting.

Standard:
120 2001
 1546 00N

 150 mm  140 g

eLite:
120 2003
 1546 50

 148 mm  95 g

TIPS & TRICKS

PRESSING AND REMOVING PLIERS FOR RIMLESS FRAMES

Compressing and Removing Sleeves is Easy and Simple!

Pressing Pliers with Rocker

No. 108 0764, 120 2069

Removing Pliers

No. 108 0763, 120 2075

Lens Protection Shim Plate with Long Holes

No. 109 6681

Special Front Cutter for Plastic Sleeves

No. 120 2080



approx. 5 minutes

This is how it works



COMPRESSING:

1 INSERTING



2 CUTTING



3 PLACING



REMOVING:

4 COMPRESSING



1 CUTTING



2 REMOVING



SWITCH THE JAW:

1 DISMANTLING



2 TURNING



3 TIGHTEN







Pressing Pliers with Rocker

For pressing in plastic sleeves on rimless frames such as Silhouette "Minimal Art" or similar models. With vertical and horizontal groove and rocker to balance the angle.

Standard:

108 0764

1567 00N

 150 mm  140 g

eLite:

120 2069

1567 50

 148 mm  95 g

Replacement plastic jaws:

108 1419

1567 01

 1 pair





Removing Pliers with Rotatable Jaws

To remove plastic sleeves from the drill holes of rimless frames such as Silhouette "Minimal Art" or similar models. Rotatable jaw with vertical and horizontal pins.

Standard:

108 0763

1568 00N

 150 mm  140 g

eLite:

120 2075

1568 50

 148 mm  95 g

Replacement plastic jaws:

108 1420

1568 01

 1 pair



Pressing Pliers

For pressing in plastic sleeves on rimless frames such as Silhouette "Minimal Art" or similar models.
With vertical and horizontal groove.

Standard:

108 2134

1511 00N

150 mm 145 g

eLite:

120 1917

1511 50

145 mm 100 g

Replacement plastic jaws:

120 1909

1511 01

1 pair



Pressing Pliers with O-rings

For pressing in plastic sleeves on rimless frames such as Silhouette "Minimal Art" or similar models. With horizontal groove. Comparable to model no. 108 2134, but is offered with a deeper groove and exchangeable rubber O-rings. Comes complete with 5 O-rings.

Standard:

120 1915

1511 10N

150 mm 145 g

Replacement plastic jaws:

120 1911

1511 02

1 pair

Replacement O-rings:

120 1913

1511 03

5 pieces



For years our bestseller and not without reason

With its rubberized, ergonomic handles and integrated opening spring for quick and automatic opening of the pliers, the special front cutter offers a high level of comfort for professional use in the workshop. The filigree cutting edges reduce the risk of scratching the glasses and set smooth cutting edges, even with soft plastic sleeves. The improved material properties of the cutting edge and the exclusive use of plastics guarantee a long service life.



Special Front Cutter for Plastic Sleeves

For cutting plastic sleeves on frames such as "Minimal Art" from Silhouette. The narrow shape of the jaws and the filigree cutting edges reduce the danger of scratching the lenses.

Not suitable for cutting metal.

Standard:

120 2077

1569 00N

140 mm

140 g

eLite:

120 2080

1569 50

137 mm

95 g

With plastic grip and opening spring:

120 2079

1569 11

115 mm

70 g

eLite: smaller, lighter and with matt finish



Special Side Cutter for Plastic

For cutting nylon liner near a drilled hole. The narrow shape of the jaws and the filigree cutting edges reduce the risk of scratching the lenses. **Not suitable for cutting metal.**

eLite:
108 0772
 1583 50
 | 100 mm | 40 g



Special Pliers for Screwless Rimless Frames

Pliers with two notches for easy disassembly of screwless frames such as Silhouette "Minimal Art" or similar models.

Standard:
120 1943
 1518 00N
 | 140 mm | 140 g

eLite:
120 1945
 1518 50
 | 137 mm | 95 g

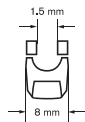
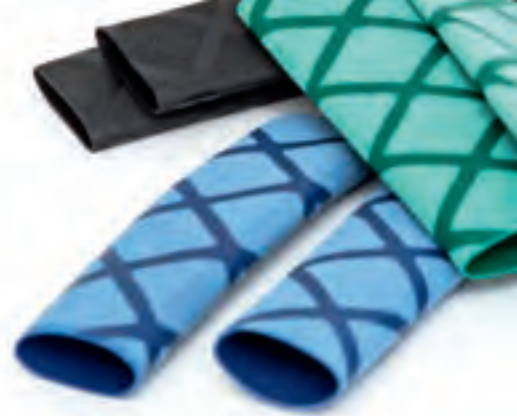

You will find our practical shrinking tubes for plier handles on page B 46.



Rimless Frame Adjusting Pliers

Specially for aligning rimless spectacles.
Secure grip of the screws and nuts.

Standard:
109 2198
1539 00N

155 mm 140 g

Replacement plastic jaw:

109 2209
1539 01

Screw Cutter

For cutting German Silver and brass screws on rimless frames.
Not suitable for steel screws.

Standard:
120 2089
1578 00N

130 mm 125 g

eLite: smaller, lighter and with matt finish



Hinge Setting or Angling Pliers

With two concave indentations,
parallel mouth gap at 1 mm.
Width of mouth: 4.0 mm

Standard:

120 2006

1548 00N

—| 148 mm ●▲ 140 g

eLite:

120 2008

1548 50

—| 137 mm ●▲ 90 g



Hinge Adjusting Pliers

To easily bend and adjust roll joint.

Standard:

120 2029

1555 00N



—| 145 mm ●▲ 140 g



Hinge Adjusting Pliers

Width of mouth: 1.5 mm

Standard:
120 1981
1538 00N



 148 mm  140 g



Windsor Rim Pliers

For notching or cutting of Windsor rims.

Standard:
120 2098
1580 00N

 150 mm  150 g

TIPS & TRICKS
BIONIC THUMB

For the Necessary Strength in the Thumb

Bionic Thumb
No. 109 2463, 64
Pro Screwdriver
used for example:
No. 120 2159

 approx. 1 minute

This is how it works



**FOR ADJUSTING:****1** TEMPLES**2** TEMPLE TIPS**3** FRAME FRONT**4** NOSE PAD ARMS**TO PROTECT:****1** SCREWING





Original Bionic Thumb

- For bending different frame parts
- Super handy and easy to use
- Made of brushed stainless steel with durable suede bending surfaces

109 2463
2045 00000  1 piece

 135 x 15 x 22 mm  90 g

109 2464
2045 01000  2 pieces

 135 x 15 x 22 mm  90 g

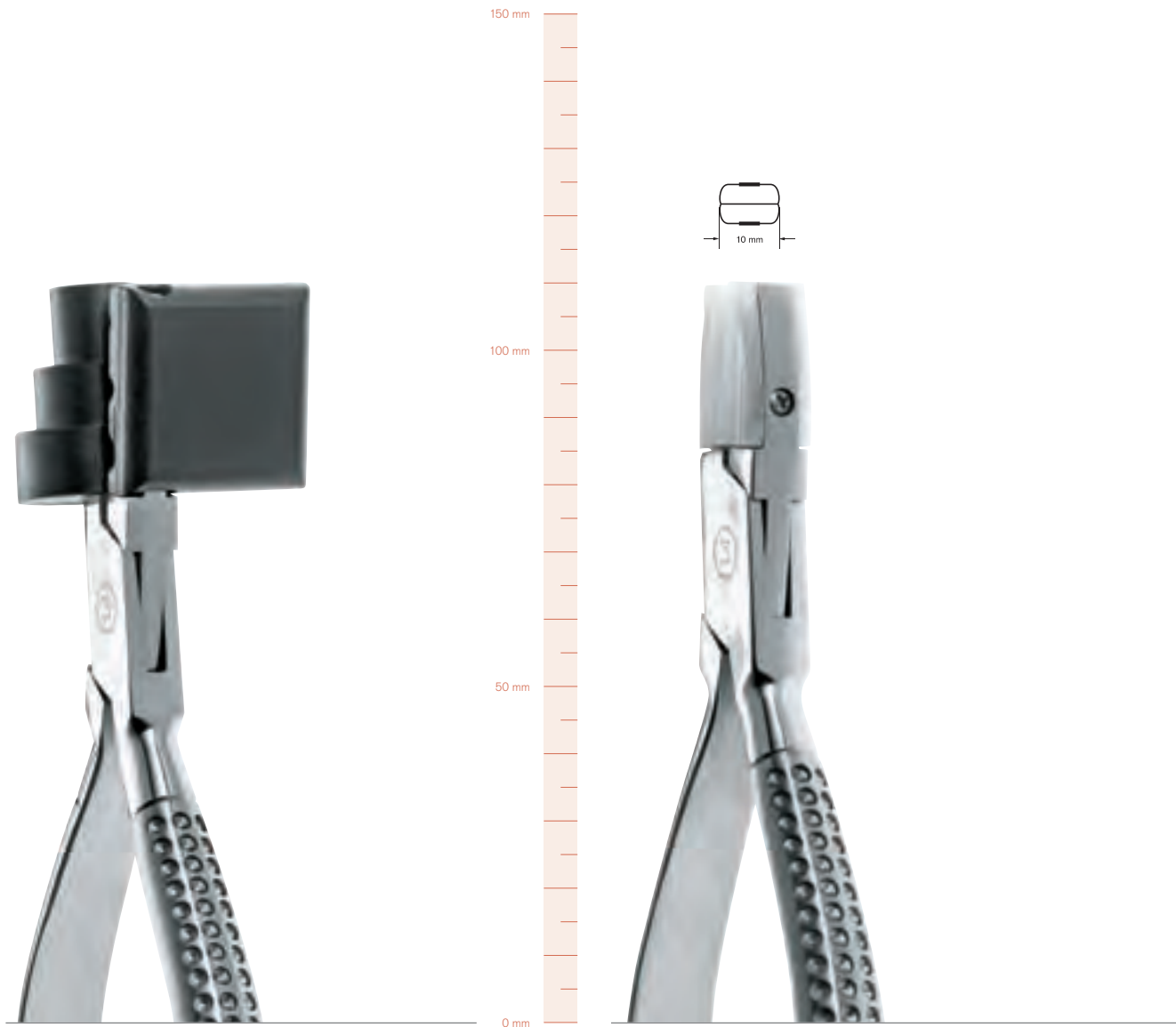

Temple Adjusting Pliers

One flat plastic jaw with three different grooves and one round plastic jaw with three different curves. Ideal to adjust all types of temples. The even distortion and constant pressure applied to the workpiece ensure a method of working which takes special care of the material.

Standard:

108 0765
1541 00N

150 mm 140 g

Replacement plastic jaws:

108 1416

1541 01

1 pair



Temple Adjusting Pliers

With two special plastic jaws, one convex and one concave, both jaws have crossgrooves vertical to the curves.

Standard:

108 0769
1530 00N

150 mm 140 g

Replacement plastic jaws:

108 1421

1530 01

1 pair



Peening Pliers

With screw on peening tip and point shaped sunken anvil to avoid marking the frame.

Standard:

120 1957
1527 10N
| 150 mm  140 g

eLite:

120 1961
1527 50
| 140 mm  95 g

Replacement peening tips:

120 1980
1537 02  3 pieces

Peening Pliers – Angled

Front part is angled for better handling in areas which are difficult to access. Screw on peening tip and point shaped sunken anvil to avoid marking the frame. Mouth remains in parallel position at a gap of approx. 3 mm.

Standard:

120 1959
1527 20N
| 145 mm  150 g

eLite:

120 1963
1527 55
| 140 mm  110 g

Replacement peening tips:

120 1980
1537 02  3 pieces



Lens Aligner 32 mm

Extra long jaws with straight ends, non-slip punched rubber discs.
 Fixed rubber jaw: Ø 32 mm (punched Ø 15 mm), flexible rubber jaw:
 Ø 26 mm, working clearance of jaws: 40 mm.

Standard:

109 2195

1516 01N

|—| 200 mm ●▲ 240 g

Replacement rubber discs:

109 2208

1532 01

▢ 1 pair

Replacement plate complete with spring:

120 1975

1534 02



Lens Aligner 20 mm

Same as No. 109 2195, but with two Ø 20 mm discs.
 Spring mechanism on the handle. Especially for small frames.

Standard:

108 0768

1516 20N

|—| 200 mm ●▲ 240 g

Replacement rubber discs:

108 1422

1535 20

▢ 1 pair



Chipping Pliers

With exchangeable jaws, including replacement jaws.

Standard:

120 2047

1561 00N

—| 145 mm  140 g

Replacement jaws:

120 2049

1561 02

 1 pair



Handle cover for pliers –
your advantage at work from B & S

- **Better grip**
- **Comfortable working**



You will find our practical shrinking tubes for pliers handles on page B 46.

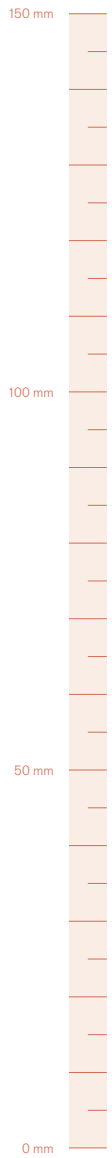

De-Blocking Pliers

For easy removal of lens blocks made of plastic or silicone, application vertical.

Standard:
108 0771
1520 00N

—| 148 mm ●▲ 140 g



De-Blocking Pliers for NIDEK

Special pliers for de-blocking the NIDEK lens block suitable for NIDEK Mini Cup and the approved P-Cup.

Standard:

109 2199

1592 00N

 148 mm

 140 g

De-Blocking Pliers for NIDEK

Special pliers for de-blocking the NIDEK lens block suitable for NIDEK Mini Cup and the approved P-Cup.

eLite:

108 0770

1591 50

 145 mm

 125 g

Replacement jaws:

109 2210

1591 01

 1 pair

Mark all your spectacle frames with your company logo.

We produce the stamp inserts according to specimen type or drawing you send to us with the order. If you do not prescribe the letter height we produce them in 1.5 mm. If the character has a border, this is adjusted in size ratio and the font height of 1.5 mm won't be changed. The maximum letter height is 2.0 mm. More than nine letters are not recommended, otherwise a perfect impression cannot be guaranteed.



Calculation of the stamp price

Use the order numbers below to determine the correct code for the number of characters. For example, if you would like to order the punch **BRO** for the CLAVULUS, you will find under No. 120 2631. This is only valid for letters that are DIN-Norm. **Special signs – engravings** such as spectacle frames, a monocle, a logo or other styles of writing and decoration, which are different to the above example and depending on the grade of difficulty **will be subject to a quotation.**

Calculation examples for inserts with 1.5 mm letter height:

Examples of signs:
 K5 calculated as: 2 signs
 B R O calculated as: 3 signs
 Special signs such as



Marking Pliers

For marking spectacle frames. Inserts made to your request.

Standard:
120 2109
 1590 00

165 mm 280 g



Stamp for Marking Pliers No. 120 2109

- 120 2112** 1590 31 1 sign
- 120 2113** 1590 32 2 signs
- 120 2114** 1590 33 3 signs
- 120 2115** 1590 34 4 signs



Stamp for CLAVULUS



- 120 2629** 2125 31 1 sign
- 120 2630** 2125 32 2 signs
- 120 2631** 2125 33 3 signs



Side Cutter

With double joint and inserted hard metal cutting blades, used for hard wire and steel screws **up to 1.4 mm** diameter.

Standard:
120 2091
1579 00N

 180 mm  240 g



Double Joint Front Cutter

With bevel, double joint and inserted hard metal cutting blades used for hard wire and steel screws **up to 1.4 mm** diameter.

Standard:
120 2096
1579 79N

 170 mm  240 g



Front Cutter

With inserted hard metal cutting blades for stainless steel screws up to a maximum of 1.4 mm.

Standard:
120 2087
 1577 10N

—| 145 mm ●▲ 140 g

Side Cutter

With inserted hard metal cutting blades for steel wires up to a maximum of 2.0 mm.

With plastic grip:
120 2100
 1581 00

—| 175 mm ●▲ 200 g

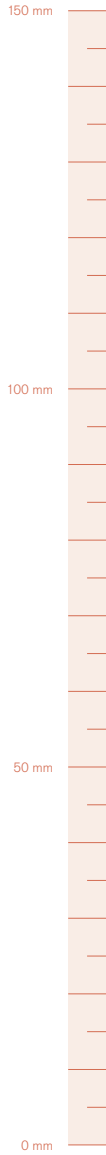

In case you use our side cutters with materials that are a greater diameter than is recommended, for example if you are cutting toughened steel, you risk breaking or damaging the side cutter. The cutting edges should if possible be used in the middle and not on the top or front edges.



Side Cutter

With inserted hard metal cutting blades for stainless steel screws **up to a maximum of 1.4 mm.**

Standard:
120 2082
 1570 00N

| 140 mm ●▲ 140 g



Side Cutter

For steel screws **up to a maximum of 1.6 mm,** with plastic grip.

With plastic grip:
109 2200
 1574 00

| 140 mm ●▲ 145 g



Side Cutter

Larger version of the side cutter No. 108 0774.
For steel and titanium screws **up to 1.4 mm**.

With plastic grip:

108 0773

1576 15

|—| 130 mm ●▲ 100 g

TIPS & TRICKS
EASY MOUNTING OF SPRING HINGES
Make Spring Hinge Mounting a Piece of Cake!
Set of Spring Hinge Pliers

No. 120 1931

or separately:

Spring Hinge Pliers

No. 120 1925

Hand Tool

No. 120 1928

Screw Driving Tweezer

No. 120 2145

Spare Pins

No. 120 1929

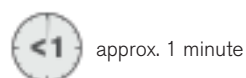
This is how it works
Option 1: Mounting with pliers, tweezer and hand tool
1 ATTACHING

2 STRETCHING

3 HOLDING

4 CLAMPING

5 ATTACHING

6 TIGHTEN, RELEASE THE PLIER

Option 2: Mounting with pins, tweezer and hand tool | Repeat step 1-3
4 CLAMPING

5 ATTACHING

6 TIGHTEN, RELEASE THE PIN

Set of Spring Hinge Pliers

The pliers clamp just the eyelet of the hinge. No scratching of the temple! The eyelet of the hinge is clamped and locked with the pliers or the pins. This simplifies the screw fitting. The handy clamping tool No. 120 1928, the pins No. 120 1929 and the tweezers No. 120 2145 are included.



"Easy Mounting of Spring Hinges"
(see page B 43)

120 1931
1514 99



Spring Hinge Pliers with Pins and Tool

120 1925
1514 55

Replacement tool:

120 1928
1514 56

Spare pins:

120 1929
1514 58

 3 pieces

Screw Driving Tweezer

120 2145
1627 00





Design
Award
Winner
2000

Pliers Stand

"Made in Germany", of beech wood with metal support for approx. 10 pliers, storage area with metal border.

Compatible with
**120 2172 Screwdriver-Set
in wooden block**

With 4 screwdrivers, screwdriver blade 1.0;
1.4; 1.8 and 2.3 mm, plus 1 Phillips head
screwdriver size 2.0 mm

Contents not included!

120 1828
1460 40

 200 x 130 x 105 mm

 960 g

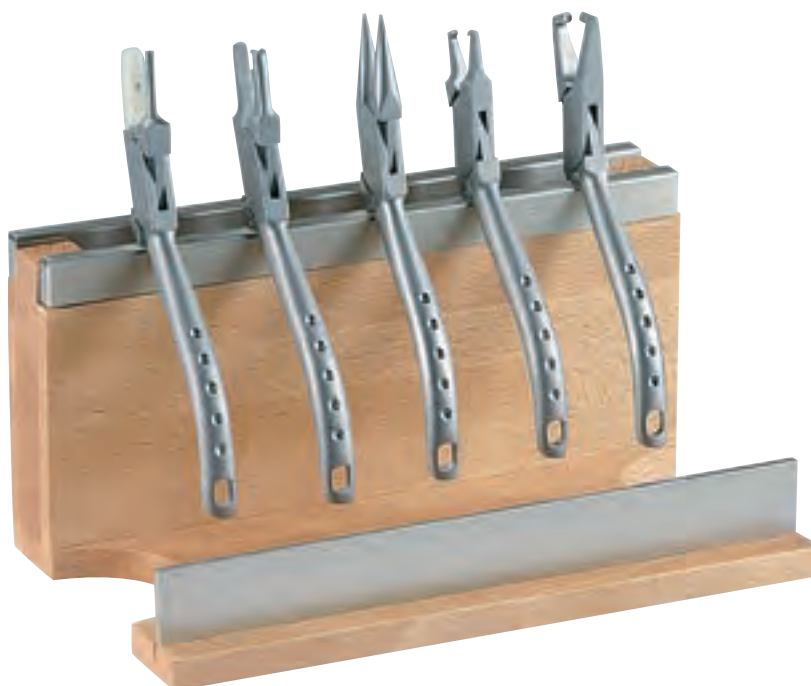

Pliers



Pliers Stand

Colour: Transparent

Acrylic plastic, with 6 drill holes dia. 10 mm
and 6 drill holes dia. 12 mm to store screw-
drivers etc.

Contents not included!

120 1825
1460 17

 300 x 130 x 165 mm

 700 g



Shrinking Tubes for Plier Handles

Cut to length of plier handles. The shrinkable handle cover has a structured surface for better grip. Both ends are open, fits tight to the handles after shrinking.

∅ 15 mm

120 1841-44  4 pairs (each 8 cm)

120 1841 1468 00 Black **120 1843** 1468 02 Red

120 1842 1468 01 Blue **120 1844** 1468 03 Green

120 1845 1468 11 Blue  1 m



Assortment with all colours



120 1846 1468 50  16 pairs (4 pairs each colour)

Pliers Stand

Stainless steel, to store approx. 10 pliers. With rubber feet to avoid scratches on the table top

Contents not included!

120 1831 1461 10

 180 x 100 x 110 mm  450 g

Matching rubber rings
Colour: Black

120 1832 1461 11  4 pieces





Pliers Stand

Transparent acrylic plastic, to store up to 5 pliers or 10 pliers. Pliers stand comes unassembled, can easily be assembled without tools.



Contents not included!

New size:

120 1826 1460 18 For approx. 5 pliers

 120 x 125 x 120 mm  200 g

120 1827 1460 19 For approx. 10 pliers

 238 x 112 x 125 mm  400 g

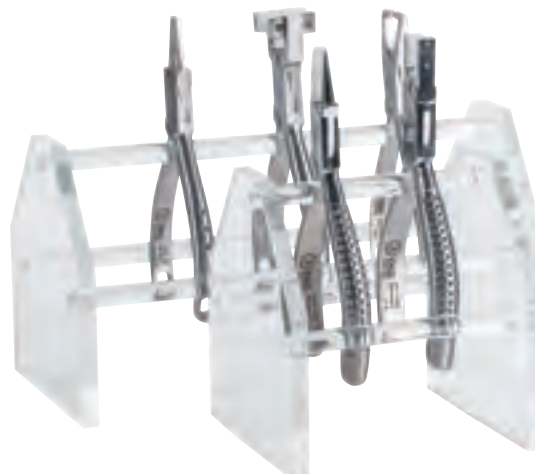

Magnetic Tool Bar for Tools

Contents not included!

121 1520
1411 08

 515 x 45 x 18 mm

 435 g



B & S Tool Case including Tools

Handy kit ready to go!
It contains the most useful pliers and spare parts for adjusting and refurbishing spectacles.

Including the following tools:

1x 120 2044, 1x 120 2024, 1x 120 2012,
1x 120 2008, 1x 120 2156, 1x 120 2144,
1x 120 2282, 1x 120 2855, 1x 120 2150,
1 accessory box with nose pads and screws

109 8943
1464 00

 270 x 150 x 50 mm

 730 g



Tool Bag Small for Belt Wear

Practical tool bag to wear on a belt.
To store pliers, pens, PD-rulers, etc.

120 1840
1467 00

 190 x 210 x 190 mm

 430 g







PRECISION TOOLS

for complicated procedures



- C 2 Screwdrivers & Nutdrivers
- C 14 Third Hand
- C 15 Rook Anvil
- C 16 Tweezers
- C 18 Cutting Tools
- C 21 Reamers
- C 22 Screw Taps
- C 24 Tips & Tricks: Lens Protection Henry
- C 26 Tips & Tricks: Nylon Liner Tool
- C 27 Rimless Frames Glazing Tools
- C 28 Tips & Tricks: Screw Cutter
- C 31 Small Tools
- C 32 Drills and Millers
- C 37 Tool Holders
- C 38 Files
- C 42 Ball Joint Vices
- C 43 Saws



B & S Screwdrivers for Professionals “Made in Germany”

Durability, precision and perfect function.

No twisting or chipping of the screwdriver blades: hardened and refined knife blade steel for the perfect combination of hardness and flexibility.

Quickchange of the blade: perfectly accurate fit between blade and grip by simple clamping.

No pressure marks in your hand: ergonomic design, proven to work, offers a high level of functionality.

Don't be satisfied with anything less.

B & S Designed Pro Screwdriver

- Blade changing support for screwdriver and nutdriver
- With longer grip surface and bigger knob for comfortable work
- Coloured knob, the oval shape prevents the screwdriver moving on the workbench
- Shaft size 2.5 mm, blades to be clamped

120 2158-63 | 115 mm



120 2159

1664 01

Green

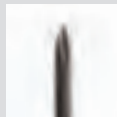

Blade width:
⊕ 1.5 mm

Spare blade:
120 2270
1711 26

120 2158

1664 00

Green

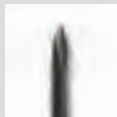

Blade width:
⊕ 2.0 mm

Spare blade:
120 2269
1711 25

120 2160

1664 10

Grey

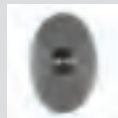

Blade width:
⊖ 1.0 mm

Spare blade:
120 2264
1711 10

120 2161

1664 14

Blue

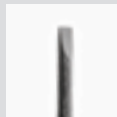

Blade width:
⊖ 1.4 mm

Spare blade:
120 2265
1711 14

120 2162

1664 18

Red

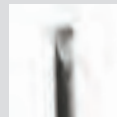

Blade width:
⊖ 1.8 mm

Spare blade:
120 2266
1711 18

120 2163

1664 23

Black

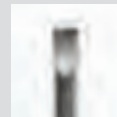

Blade width:
⊖ 2.3 mm

Spare blade:
120 2268
1711 23



Spare blades: Shaft size 2.5 mm, blades to be clamped

3 pieces

Pro Screwdriver Set

- In a semi-circular wooden stand
- With 5 screwdrivers from the B & S Pro series
- 4 slotted blades 1.0; 1.4; 1.8; 2.3 mm, 1 Phillips head 2 mm

120 2172

1664 50



Design
Award
Winner
2000

Insertion Cup Holder Set

- 5 insertion cups, marked with different sizes
- To insert into desktops or the dispensing area

120 1839

1465 50



OptiCar – Including Screwdrivers

- High quality metal design with free moving solid rubber wheels
- With 5 screwdrivers from the B&S Pro series
- 4 Slotted blades 1.0, 1.4, 1.8, 2.3 mm
- 1 Phillips head 2.0 mm

120 2173
1664 60



Revolving Depot

- Revolving aluminium stand
- With 6 screwdrivers from the B&S Pro series
- 4 Slotted blades 1.0; 1.4; 1.8; 2.3 mm
- 2 Phillips head 1.5 and 2.0 mm

120 2174
1664 61



Plastic Depot

- With 6 screwdrivers from the B&S Pro series
- 4 Slotted blades 1.0; 1.4; 1.8; 2.3 mm
- 2 Phillips head 1.5 and 2.0 mm

120 2175
1664 62



B & S Nutdrivers for Professionals “Made in Germany”

Durability, precision and perfect function.
 No twisting or chipping of the screwdriver blades: hardened and refined knife blade steel for the perfect combination of hardness and flexibility.
 Quick change blade: perfectly accurate fit between blade and grip by simple clamping.
 No pressure marks in your hand: ergonomic design, proven to work, offers a high level of functionality.
 Don't be satisfied with anything less.



B & S Designed Pro Nutdriver

- Blade changing support for screwdriver and nutdriver
- With longer grip surface and bigger knob for comfortable work
- Coloured, oval knob prevents moving on the workbench
- Shaft size: 2.5 mm, blades to be clamped



120 2164-71 | 115 mm

120 2164	120 2165	120 2166	120 2167	120 2168	120 2169	120 2170	120 2171
1664 40	1664 42	1664 43	1664 44	1664 45	1664 46	1664 48	1664 49
⊗ 2.2 mm	⊙ 2.6 mm	⊗ 2.6 mm	⊙ 2.2 mm	⊗ 2.0 mm	⊗ 2.1 mm	⊙ 2.0 mm	⊙ 2.3 mm
Star nuts, 6 points	Big hex nuts	Big star nuts, 6 points	Small hex nuts	Big star nuts, 4 points	Star nuts, 6 points, for the most common nuts	Hex socket star type, 6 points	Hexagonal, for dome nuts
Spare blade: 120 2273 1711 40	Spare blade: 120 2274 1711 42	Spare blade: 120 2275 1711 43	Spare blade: 120 2276 1711 44	Spare blade: 120 2277 1711 45	Spare blade: 120 2278 1711 46	Spare blade: 120 2279 1711 48	Spare blade: 120 2280 1711 49
				Spare blades: Shaft size 2.5 mm, blades to be clamped			
				📦 3 pieces			

OptiCar – Including Nutdrivers

- High quality metal design with free moving solid rubber wheels
- With 5 nutdrivers from the B & S Pro series
- 2 Hexagon 2.3; 2.6 mm
- 3 Star 2.1; 2.2; 2.6 mm

120 2176
1664 70



Revolving Depot

- Revolving aluminium stand
- With 8 nutdrivers from the B & S Pro series
- 4 Hexagon 2.0; 2.2; 2.3; 2.6 mm
- 4 Star 2.0; 2.1; 2.2; 2.6 mm

120 2177
1664 71



Plastic Depot

- With 8 nutdrivers from the B & S Pro series
- 4 Hexagon 2.0; 2.2; 2.3; 2.6 mm
- 4 Star 2.0; 2.1; 2.2; 2.6 mm

120 2178
1664 72



B & S Screwdriver from the Standard Series

- Blade changing support for screwdriver and nutdriver
- Ribbed grip surface for perfect grip
- Coloured, **round knob flattened on one side**, to prevent the screwdriver moving on the workbench
- Wing blades to avoid twisting inside the handle
- Shaft size: 3.0 mm, wing blade



120 2190-95 | 110 mm

120 2191 1682 01 Green	120 2190 1682 00 Green	120 2192 1682 10 Grey	120 2193 1682 14 Blue	120 2194 1682 18 Red	120 2195 1682 20 Black
Blade width: + 1.5 mm	Blade width: + 2.0 mm	Blade width: - 1.0 mm	Blade width: - 1.4 mm	Blade width: - 1.8 mm	Blade width: - 2.0 mm
Spare blade: 120 2202 1682 46	Spare blade: 120 2201 1682 45	Spare blade: 120 2196 1682 30	Spare blade: 120 2197 1682 34	Spare blade: 120 2198 1682 38	Spare blade: 120 2199 1682 40
					Spare blades: Shaft size 3.0 mm, wing blade 3 pieces

Revolving Depot

- With 6 screwdrivers from the B & S Standard series
- 4 Slotted blades 1.0; 1.4; 1.8; 2.0 mm
- 2 Phillips head 1.5 and 2.0 mm

120 2204
1682 61



Plastic Depot

- With 6 screwdrivers from the B & S Standard series
- 4 Slotted blades 1.0; 1.4; 1.8; 2.0 mm
- 2 Phillips head 1.5 and 2.0 mm

120 2205
1682 62











B & S Nutdriver from the Standard Series

- Blade changing support for screwdriver and nutdriver
- Ribbed grip surface for perfect grip
- Coloured, **round knob flattened on one side**, to prevent the screwdriver moving on the workbench
- Wing blades to avoid twisting inside the handle
- Shaft size: 3.0 mm, wing blade

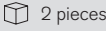

120 2206-13 | 110 mm

120 2206 1682 70 2.2 mm	120 2207 1682 72 2.6 mm	120 2208 1682 73 2.6 mm	120 2209 1682 74 2.2 mm	120 2210 1682 75 2.0 mm	120 2211 1682 76 2.1 mm	120 2212 1682 78 2.0 mm	120 2213 1682 79 2.3 mm
							
Star nuts, 6 points	Big hex nuts	Big star nuts, 6 points	Small hex nuts	Big star nuts, 4 points	Star nuts, 6 points, for the most common nuts	Hex socket star type, 6 points	Hexagonal, for dome nuts
Spare blade: 120 2214 1682 80	Spare blade: 120 2215 1682 82	Spare blade: 120 2216 1682 83	Spare blade: 120 2217 1682 84	Spare blade: 120 2218 1682 85	Spare blade: 120 2219 1682 86	Spare blade: 120 2220 1682 88	Spare blade: 120 2221 1682 89
				 Spare blades: Shaft size 3.0 mm, wing blade  2 pieces			



Revolving Depot

- With 8 nutdrivers from the B & S Standard series
- 4 Hexagon 2.0; 2.2; 2.3; 2.6 mm
- 4 Star 2.0; 2.1; 2.2; 2.6 mm

120 2222
1682 91



Plastic Depot

- With 8 nutdrivers from the B & S Standard series
- 4 Hexagon 2.0; 2.2; 2.3; 2.6 mm
- 4 Star 2.0; 2.1; 2.2; 2.6 mm

120 2223
1682 92



B & S Hex Driver from the Standard Series

- Blade with wings is fixed with an additional screwed cover
- Ribbed grip surface for perfect grip
- Coloured, **round knob flattened on one side**, to prevent the screwdriver moving on the workbench
- Hex driver for screws with hex bolt
- Shaft size: 3.0 mm

120 2229-32 | 110 mm



120 2229

1684 13

Hexagon 1.3

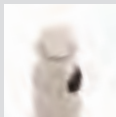

Spare blade:

120 2239

1684 63

120 2230

1684 15

Hexagon 1.5

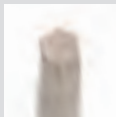

Spare blade:

120 2240

1684 65

120 2231

1684 20

Hexagon 2.0

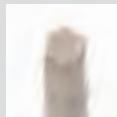

Spare blade:

120 2241

1684 70

120 2232

1684 21

Hexagon 2.1

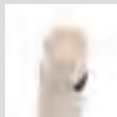

Spare blade:

120 2242

1684 71



Spare blades:

Shaft size 3.0 mm, wing blade

 3 pieces









You will find our Torx screws
on page F 40.

B & S Torx Driver from the Standard Series

- Blade with wings is fixed with an additional screwed cover
- Ribbed grip surface for perfect grip
- Coloured, **round knob flattened on one side**, to prevent the screwdriver moving on the workbench
- Torx driver for screws with star bolt
- Shaft size: 3.0 mm

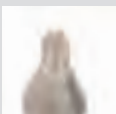
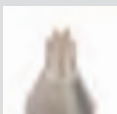
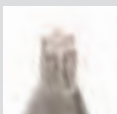
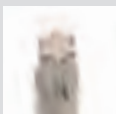
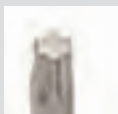

120 2233-37 | 110 mm

120 2233 1684 32 Torx 2	120 2234 1684 33 Torx 3	120 2235 1684 34 Torx 4	120 2236 1684 35 Torx 5	120 2237 1684 36 Torx 6	
					
					
Spare blade: 120 2243 1684 82	Spare blade: 109 6714 1684 83	Spare blade: 109 6715 1684 84	Spare blade: 109 6716 1684 85	Spare blade: 109 6717 1684 86	Spare blades: Shaft size 3.0 mm, wing blade
					 3 pieces



Torx Screw Driver Set

- Grips of the standard series including blades
- Torx driver set in a handy box
- Blade with wings is fixed with an additional screwed cover
- Blue knobs with marking simplifies the identification
- Coloured, **round knob flattened on one side**, to prevent the screwdriver moving on the workbench
- With 4 screwdriver: Torx sizes 3, 4, 5 and 6

120 2238
1684 50



B & S Designed Screwdriver with Blade Storage

With large **oval** revolving plastic knob and 5 blades (accomodated in handle).
The oval head prevents the screwdriver moving on the workstation.

Shaft size: 2.5 mm

Blade width: ● 1.0; 1.4; 1.8; 2.3 mm, ⊕ 2.0 mm

120 2179 | 119 mm | 35 g
1666 00



 Suitable replacement blades
No. 120 2264–66 and 120 2268–70
can be found on page C 2.

Screwdriver with Blade Storage

With plastic grip, large round revolving knob and 5 blades (accomodated in handle).
Shaft size: 2.5 mm

Blade width: ● 1.0; 1.4; 1.8; 2.3 mm, ⊕ 2.0 mm

120 2188 | 119 mm | 31 g
1678 00



 Suitable replacement blades
No. 120 2264–66 and 120 2268–70
can be found on page C 2.

Screwdriver with Blade Storage

Same design as No. 120 2188, but with one blade only.
Shaft size: 2.5 mm

Blade width: ● 1.8 mm

120 2248 | 119 mm | 21 g
1690 00



 Suitable replacement blade
No. 120 2266
can be found on page C 2.

Universal Screwdriver with Blade Storage

Nickel plated brass, with revolving plastic knob and 4 blades.
Shaft size: 2.5 mm

Blade width: ● 1.5; 1.8; 2.3 mm, ⊕ 2,0 mm

120 2282 | 115 mm | 30 g
1717 00



 Suitable replacement blades
No. 120 2264–66 and 120 2268–70
can be found on page C 2.

Small Metal Screwdriver

- With 5 different functions: Slotted, Phillips and 3 nutdriver blades
- Blade width: \ominus 1,8 mm, \oplus 1,8 mm
- Nutdriver: 2.02; 2.32 and 2.57 mm
- Colours: Blue, Red, Green, Purple, Orange

120 2356  10 pieces (2 per colour)
1798 16

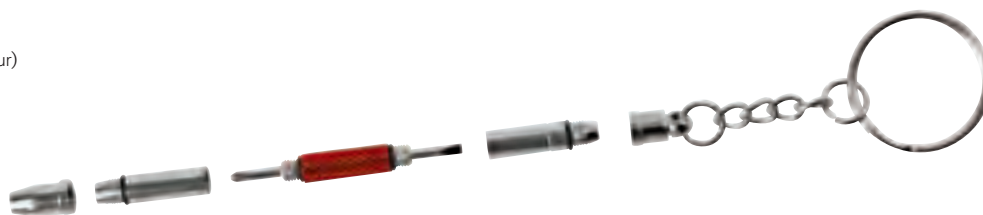

Counter Display

- With 10 small screwdriver No. 120 2356, with 5 functions
- Dimensions: DIN A4

120 2358
1798 56



Spare Blades (without illustration)

Blade width	Type	Kind of blade	Available for	Order No.	
1.0 mm	\ominus	Blade	1662 10*, 1680 10*, 1700 10*	120 2260 1693 10	3 pieces
1.5 mm	\ominus	Blade	1662 15*, 1680 15*, 1700 15*	120 2261 1693 15	3 pieces
1.8 mm	\ominus	Blade	1662 18*, 1680 18*, 1700 18*	120 2262 1693 18	3 pieces
2.3 mm	\ominus	Blade	1662 23*, 1680 23*, 1700 23*, 120 2294	120 2263 1693 23	3 pieces
1.0 mm	\ominus	Blade	1669 .. *	120 2183 1669 10	2 pieces
1.4 mm	\ominus	Blade	1669 .. *	120 2184 1669 14	2 pieces
1.8 mm	\ominus	Blade	1669 .. *	120 2185 1669 18	2 pieces
2.0 mm	\oplus	Crossblade	1669 .. *	120 2187 1669 25	2 pieces
2.3 mm	\ominus	Blade	1682 23*, 1683 23*	120 2200 1682 43	3 pieces

* discontinued



A perfect Set.

From the Black Forest in Germany onto your work-bench. Assorted by sizes in a beech wooden case. Seven lean nutdrivers with the most used nutdriver blades made of high quality steel. The stop inside the blade which is typically for B&S nutdrivers prevents the nut from annoyingly "disappearing" into the shaft.

Nutdriver Set

Content 7 nutdrivers:



No. 120 2334; 120 2336; 120 2338;
120 2340; 120 2342; 120 2346 and
120 2350

120 2333
1741 15

 13,5 x 2,4 x 12 cm



Single available:

 100 mm  15 g

120 2334	120 2336	120 2338	120 2340	120 2342	120 2344	120 2346	120 2348	120 2350
1742 00	1743 00	1744 00	1745 00	1746 00	1747 00	1748 00	1749 00	1767 00
⊙ 2.6 mm	⊙ 2.6 mm	⊙ 2.2 mm	⊙ 2.0 mm	⊙ 2.1 mm	⊙ 2.8 mm	⊙ 2.0 mm	⊙ 2.3 mm	⊙ 2.2 mm

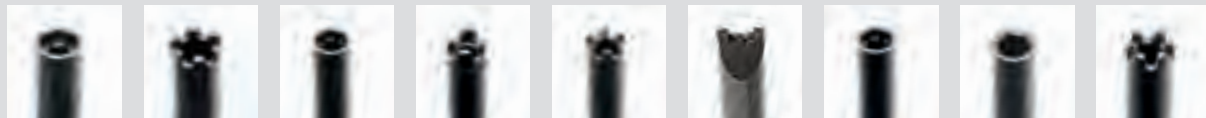

Grip No. 2	Grip No. 3	Grip No. 4	Grip No. 5	Grip No. 6	Grip No. 7	Grip No. 8	Grip No. 9	Grip No. 0
Big hex nuts	Big star nuts, 6 points	Small hex nuts	Big star nuts, 4 points	Star nuts, 6 points, for the most common nuts	Slotted nuts	Hex socket star type, 6 points	Hexagonal, for dome nuts 120 1312–14	Star nuts, 6 points, for big star nuts

Nutdriver Set

Content 5 nutdrivers:

No. 120 2336; 120 2338; 120 2340; 120 2342
and 120 2346

120 2332
1741 05

 13,5 x 2,7 x 9,6 cm



The number on the grip identifies the order code.

Broken screw? No problem!

Here precision and comfort goes hand in hand. Broken screws can be pushed out cleanly and precisely with this handy tool. Simply fit on the hand CLAVULUS, tighten up the wing screw and with a few turns there will be space for a new screw.

Handheld CLAVULUS

- For the removal of broken screws
- Compact and ergonomic tool
- Power precisely through the wing screw
- For material saving use
- 3 exchangeable sleeves for different screw diameters included
- Hardwearing material (stainless steel)

120 2298
1727 00



Screw Remover with Blade Storage

The sharp edged blades grip the remains of broken off screws and enable you to unscrew the screw without the use of drilling machines.

Shaft size: 2.5 mm

Each unit includes 2 blades with diameter: 1.3 and 1.5 mm

120 2257 | 119 mm | 25 g
1691 00



Spare Blades

Blade width 1.3 mm

120 2258

1691 13

Blade width 1.5 mm

120 2259

1691 15

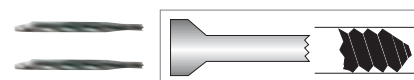

Aluminium Stand “Third Hand”

- Stable stand
- With 3 exchangeable blades in the socket for securing screws or nuts
- Shaft size: 2.5 mm, blades to be clamped

1 screwdriver blade: Blade width: 2,3 mm

1 hex nutdriver: Inner diameter: 2.2 mm

1 star nutdriver: Inner diameter: 2.1 mm

120 2294

1723 00



Suitable replacement blades
No. 120 2264–66 and 120 2268–70
can be found on page C 2.

“Third Hand” Stand (with Nut Gripper)

- A new combination of third hand stand and nut gripper
- Stable stand
- Retains nuts so that they can be screwed to the thread
- For problem free gripping of nuts

120 2296

1723 20



Metal Stand “Third Hand”

- Stable stand
- With 5 exchangeable blades and 7 functions for securing screws or nuts
- Shaft size: 3.15 mm, wing blade

1 screwdriver blade with double sided function:

Blade width: 1.5 and 1.8 mm

1 screwdriver Phillips head blade with double sided function:

Blade width: 1.5 and 1.8 mm

3 nutdriver blades (hexagon):

Inner diameter: 2.0, 2.3 and 2.5 mm

120 2301

1728 00



Aluminium Stand “Third Hand” Extra Tall for Large Wing Blades

- Stable stand
- With 5 exchangeable blades and 7 functions for securing screws or nuts
- Shaft size: 3.15 mm, wing blade

1 screwdriver blade with double sided function:

Blade width: 1.5 and 1.8 mm

1 screwdriver Phillips head blade with double sided function:

Blade width: 1.5 and 1.8 mm

3 nutdriver blades (hexagon):

Inner diameter: 2.0; 2.3 and 2.5 mm

120 2303

1728 10



Spare Blade Set (without illustration)

To metal stand “Third Hand” No. 120 2301.

Containing 5 blades.

120 2302

1728 01

Fully developed. Workplace with high quality all-rounders.

This anvil tower is produced exclusively for B & S. With its unusual shape this heavy weight offers a range of advantages: Secure standing with its massive aluminium foot. Flexibility due to the handy size. Small repairs can be fixed on the round platform. Protecting the table surface from damage makes the rook anvil attractive to use for service repairs during a consultation. Depositing area for frame parts on the top. Just try it. Everyone who tries it will never want to be without it again.

Rook Anvil

- To fix screws on joints, hinges and nose pad arms
- Robust and stable, made of solid aluminium
- Depositing area for frame parts
- Cushioned base for gently carrying out work
- Can be fixed on the table by a standard M6 screw
- For workshop and sales area

108 2029
1729 00

∅ Base x height: 80 x 80 mm

⚖️ 300 g



Spare Rubber Ring (without illustration)

108 2030
1729 01

📦 2 pieces

Optician's Anvil

- Polished chrome-plated, with round opening, one round and one square-shaped drift

120 2309
1730 10

📏 120 x 45 x 25 mm

⚖️ 425 g



Screw Driving Tweezer

- Easy fixation of the screw by means of a lock at the middle of the tweezer
- Screw is fixed and ready to screw in, essential for spring hinges
- Moving knob at the end of the handle enables easy screwing

120 2145
1627 00

📏 130 mm

⚖️ 30 g



"Easy Mounting of Spring Hinges"
(see page B 43)



Nut Gripper

- Retains nuts so that they can be screwed to the thread
- For problem free gripping of **nuts**

120 2150 | 100 mm | 35 g
1639 00



Gripper

- Recessed both sides to pick up, grip and twist **screws**

120 2148 | 75 mm | 180 g
1636 00



Tweezer – Push-in Nose Pads

- For removal of "push-in nose pads"
- Also available as pliers

120 2144 | 100 mm | 15 g
1626 00



You will find our pliers No. 120 1886 and 120 1888 on page B 18.

Tweezer – Thin Pointed

- With thin pointed tips, stainless steel

120 2146 | 110 mm | 17 g
1631 00



Tweezer – Pointed

- Pointed, nickel plated

120 2137 | 110 mm | 18 g
1621 00



Titanium Soldering Tweezer

- Advantages: solder resistant, low heat conduction, 100 % anti-magnetic, highly acid resistant, extremely light, with centering pin

120 2141 | 160 mm | 15 g
1623 10



Solder Tweezer

- With insulated grips, polished steel

120 2142 | 160 mm | 35 g
1624 00



Screw Holder

Angled – with Locking Mechanism

- A slotted notch in the tip to grip nose pads and hinge screws easily
- With a clamp to lock the screw
- The angled tip is useful for difficult to reach hinges

120 2157 | 110 mm | 11 g
1653 00

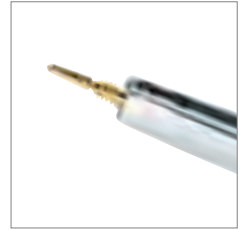

The Classic

- With grooves on both tips to hold pad screws and other small items

120 2156 | 130 mm | 30 g
1651 00



Pointed Tip

- **Stainless steel**, straight version
- Specially for pad screws
- To start rotating the screw into the thread

120 2147 | 105 mm | 10 g
1634 00



Cross Tweezer

- To start rotating the screw into the thread

120 2143 | 155 mm | 32 g
1625 00



Screw Holder with Locking Mechanism

- The locking mechanism ensures that the screw is held tightly
- Essential when fitting a screw to a spring hinge

109 6135 | 135 mm | 30 g
1637 00



Riveting Hammer

- Gunmetal finish, square-shaped head, wooden handle, rounded corners

120 2353
1781 10

|—| 260 mm  80 g



Riveting Hammer

- Metal, bi-colour, round heads, one side metal, one side plastic

120 2352
1772 00

|—| 240 mm  100 g



Trident Scraper

- Conical, with handle

120 2598
2071 00

|—| 165 mm  25 g

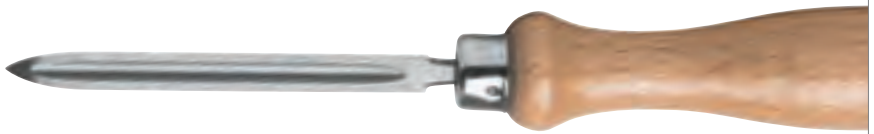

Swarf Removal Tool

- Removing the edging residue from polycarbonate and Trivex lenses
- Deburring the groove of lenses for half rimless

120 2599
2072 00

|—| 95 mm  10 g



Groove Scraper

- Suitable for rough and smooth surfaces
- Adjustable for each size

120 2600
2073 10

|—| 145 mm  40 g



Glass Cutter "Silberschnitt"®

- Superior quality "Made in Germany"

120 3051
2634 00

| 130 mm ▲ 25 g



Cutting Spoon

- For cutting glass
- Mechanised system, handy design, metal type

120 3052
2637 00

| 150 mm ▲ 30 g



Universal Cutting Wheel

- Superior quality "Made in Germany"
- For glass cutter No. 120 3051 and cutting spoon No. 120 3052

120 2719
2239 00

∅ 4.5 mm 📦 12 pieces



Illustration enlarged



Scissors for plastic

- Multiple purpose scissors with plastic covered handles for easy cutting of patterns.
- One sided toothed cut (serrated edge)

121 0105 | 155 mm | 74 g
1607 00



Small Scissors

- With straight blades and screwed joint

120 2136 | 60 mm | 18 g
1614 00



Scissor

- Refined stainless steel, adjustable with screw
- Suitable for right and left-use

120 2135 | 200 mm | 90 g
1613 10



Scalpel with Metal Handle

- Practical cutting tool for frame inserts, nylon threads, foils etc.
- No squeezed edges due to extremely sharp blades
- Metal handle **with 3 bits**
- Blade length: 35 mm

120 2126 | 150 mm | 15 g
1602 10



Spare Blades for No. 120 2126

120 2128 | 35 mm | 3 pieces
1602 15



Scalpel Set

- For cutting nylon liner
- Content: 1 handle and 8 blades in different shapes and sizes

120 2132 | 160 x 40 x 40 mm | 100 g
1604 01



Reamers

- 5-sided, high-polished, **without handle**, with shaft

120 2578-86  3 pieces

Order No.	Ø	Order No.	Ø
120 2578 2051 31	1.0 mm	120 2583 2051 36	1.7 mm
120 2579 2051 32	1.1 mm	120 2584 2051 37	1.9 mm
120 2580 2051 33	1.2 mm	120 2585 2051 38	2.0 mm
120 2581 2051 34	1.3 mm	120 2586 2051 39	2.2 mm
120 2582 2051 35	1.6 mm		



Reamer Assortment

- 5-sided shaped reamers, fine grade, **with knurled handle**
- Reamers-Ø: 1.0; 1.1; 1.2; 1.4; 1.6 and 1.8 mm

120 2587  25 g  6 pieces



Reamer Assortment for Single Jets

- With plastic handle, for cleaning of jets
- Reamers-Ø: 0.05; 0.08; 0.10; 0.15; 0.20; 0.25; 0.30; 0.35; 0.40; 0.45; 0.50 and 0.55 mm

120 3104  11 g  12 pieces



Reamer Assortment

- 5-sided reamers, fine grade **without handle**, **with** shaft and **with** holder
- Contents:** No. 120 2578; 120 2579; 120 2580; 120 2581; 120 2582; 120 2583; 120 2584; 120 2585 and 120 2586

120 2576  30 g  12 pieces

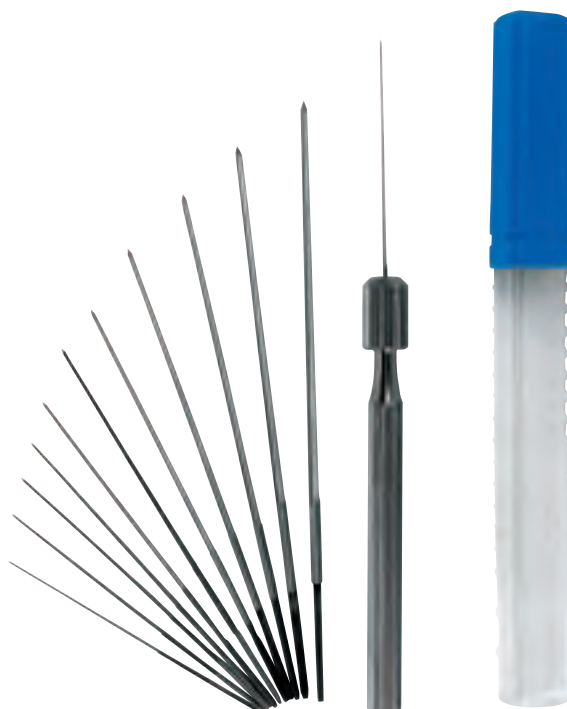

Screw Tap

- With 3 milled grooves, expertly ground and hardened for top quality finish
- For correct order no's see chart below



120 2432-41  3 pieces



Illustration enlarged

Screw Tap Handle

- Plastic, marked with individual tap sizes
- For correct order no's see chart below

 85 mm  10 g



Thread size	Shaft size	Order No. for screw taps	Order No. for screw tap handles
M 0.80 mm	1.45 mm	120 2432 1962 08	120 2314 1736 08
M 1.00 mm	1.45 mm	120 2433 1962 10	120 2316 1736 10
M 1.10 mm	1.45 mm	120 2434 1962 11	120 2318 1736 11
M 1.20 mm	1.45 mm	120 2435 1962 12	120 2320 1736 12
M 1.30 mm	1.45 mm	120 2436 1962 13	120 2322 1736 13
M 1.40 mm	1.45 mm	120 2437 1962 14	120 2324 1736 14
M 1.50 mm	1.75 mm	120 2438 1962 15	120 2326 1736 15
M 1.60 mm	1.95 mm	120 2439 1962 16	120 2328 1736 16
M 1.70 mm	1.95 mm	120 2440 1962 17	120 2330 1736 17
M 1.80 mm	2.00 mm	120 2441 1962 18	-

Screw Tap Assortment

- In wooden box
- **Contents:** 9 screw taps, ready to use, in sizes: M 0.80; M 1.00; M 1.10; M 1.20; M 1.30; M 1.40; M 1.50; M 1.60; M 1.70; 1 mandrel No. 120 2283 and 1 empty space

120 2442
1980 00



Screw Tap Assortment

- In plastic box
- **Contents:** 3 screw taps of each No. 120 2432; 120 2433; 120 2435; 120 2436; 120 2437 and 1 tool holder No. 120 2592

120 2444
1981 00



Measurement Tool for Holes

1.0 to 1.6

- Easy and quick measuring of hole sizes in lenses
- With rounded tips for an easy measuring of hole sizes in lenses
- High quality design
- 6 spikes in sizes: 1.0; 1.2; 1.3; 1.4; 1.5 and 1.6 mm

120 2286
1718 11

∅ Outer: 65 mm

▲ 10 g



Measurement Tool for Holes

1.0 to 2.4

- Easy and quick measuring of hole sizes in lenses
- With rounded tips for an easy measuring of hole sizes in lenses
- High quality design
- 10 spikes in sizes: 1.0; 1.1; 1.2; 1.4; 1.5; 1.6; 1.8; 2.0; 2.2 and 2.4 mm

120 2287
1718 12

∅ Outer: 80 mm

▲ 26 g



Mandrel

- Special support for screw setting on hinges
- Conical
- With plastic handle

120 2283
1718 00

| 105 mm

▲ 10 g



Spare Mandrel (without illustration)

- For No. 120 2283

120 2285
1718 01



TIPS & TRICKS

HENRY – A LITTLE HELPER IN MANY SITUATIONS

Triple Protection against Scratches

Lens Protection Henry

made of Silicone

No. 109 2360

Screwdrivers for Professionals

used for example:

No. 120 2162

Precision File

No. 120 2395

Side Cutter

No. 120 2091



approx. 3 minutes each

This is how it works



Option 1: While mounting nose pads

1 ATTACH



2 MOUNTING OF NOSE PADS



Option 2: While mounting rim joints

1 ATTACH



2 UNSCREW/TIGHTEN



Option 3: Cutting screws on rimless frames

1 ATTACH

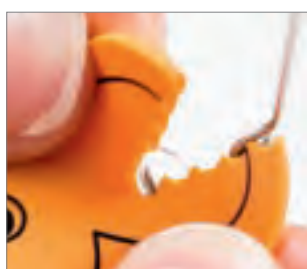

2 CUT OFF



3 LEVEL WITH A FILE



Lens Protection Henry

- Protects the lenses from scratches: while mounting nose pads, during the assembly of rimless frames and while mounting rim joints
- Made of silicone

109 2360
2272 00

 60 x 80 mm

 1 g

 2 pieces



Lens Protection Shim Plate

- Distance and protection plate for easily cutting plastic sleeves (1.4 and 1.8 mm) close to the lens
- Nylon liner (max. 1.0 mm diameter) can be fixed and shortened easily close to the lens
- Suitable to remove remnants from PC lenses after the edging process

109 6680
2269 00

 55 x 20 mm

 1 g



Lens Protection Shim Plate with Long Holes

- Distance and protection plate for easily removing the sleeves
- Facilitates the dismounting of the frame
- Suitable to remove remnants from PC lenses after the edging process

109 6681
2269 10

 50 x 11 mm

 1 g



TIPS & TRICKS
NYLON LINER TOOL

Finally the Threading is Fun

Nylon Liner Tool

No. 109 5079

Tweezer – Thin Pointed

No. 120 2146

Nylon Thread Hook

No. 120 2288

Small Scissors

No. 120 2136



approx. 5 minutes each

This is how it works

1 TAKE OFF

2 REMOVE

3 THREAD

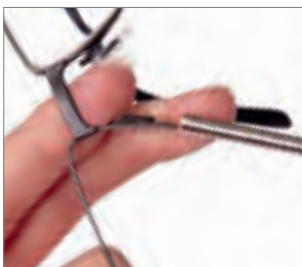
4 SET IN

5 CUT TO SIZE

6 THREAD

7 INSERT

Nylon Liner Tool

For easy threading of the 8-profile nylon liner into the upper or lower frame rim.

- Total length: 110 mm
- Diameter cylinder: 15 mm
- Nylon liner: 0.51 mm and 0.55 mm

109 5079

1365 00



You will find our nylon threads on page F 85.

Nylon Thread Hook

- For easy assembly of lenses into supra frames

120 2288

1719 00

105 mm

13 g



Sleeve Removing Tool for Rimless Frames

- Small tool which helps to get the frame and leftovers from the sleeves out of the lens
- Fits for all frames with 1.4 pins and standard drill hole distances

120 2753

2267 10

Blue

∅ 1.4 mm

75 x 10 x 25 mm

7 g



TIPS & TRICKS
FITTING TOOL FOR RIMLESS FRAMES

Shorten Screws without a Burr!

**Works as a Nut Driver and
Screw Cutter in One Tool**

For screws with 1.2 mm thread size
No. 109 7803

For screws with 1.4 mm thread size
No. 109 7804



approx. 30 seconds

This is how it works

1 MOUNTING

2 TURN AROUND

3 ATTACHING

4 CUTTING

5 DONE

Works as a Nut Driver and Screw Cutter in One Tool

109 7803-04 | 70 mm  6 g



109 7803 
2268 00

- To shorten screws with **1.2 mm** thread
- For all popular hex nuts with an outer diameter of max. **2.7 mm**

109 7804 
2268 01

- To shorten screws with **1.4 mm** thread
- For all popular star nuts with an outer diameter of max. **2.5 mm**



Drill Hole Chamfer Tool

- For easy chamfering of drill holes
- The special shape chamfers the edges quickly and effectively using just slight pressure
- Countersinks are no problem
- Clockwise rotation for clean, optimum results
- Only recommended for plastic, Polycarbonate or Trivex lenses



120 2751 | 71 mm  7 g

Tool Kit for Rimless Frames

- Practical tool kit for rimless frames
- Consisting of No. 109 7803 and 109 7804 fitting tool for 1.2 mm and 1.4 mm thread and No. 120 2750 drilled hole reamer

120 2758
2268 50



Drilled Hole Reamer

- Suitable for tool holders No. 120 2596, 120 2595 and 120 2593
- Shaft size: **1.6 mm**



120 2750
2266 10



Double Hand Miller with Hinge Miller and Screw End Miller

- To work with hinge rolls and screw ends

120 2709
2216 00

| 122 mm  5 g



Duplex Hinge and Temple Miller

- To work with joints and temple hinge rolls
- Miller size: 3.5 mm

120 2711
2220 04

| 110 mm  2 g



Screw End Miller

- For milling of screw ends (except steel screws)
- Shaft size: 2.5 mm

120 2765
2271 25

| 110 mm  2 g



Silicone Pad

- This non-slip softpad protects frame and worktop against scratches
- Perfect for your workshop and service area
- Made of silicone
- Thickness of the material: 1.5 mm



109 2361  2 pieces
2274 00



The tools No. 120 2710 (page C 36), 120 2709 and 120 2765 (page C 30) are for processing common German Silver screws and brass screws. Processing steel screws will immediately damage the tool. Improper usage voids all guarantees

Small Tools Assortment

- To use for frames
- **Contents:** 1 diamond miller, 1 diamond grinder, 1 groove miller, 1 cutting wheel (10 pieces) including mandrel, 2 grinder, 1 steel miller, 1 brass wire brush, 3 buffing wheels, 4 silicone polishers, 1 trimming wheel
- In practical box
- Shaft size: 2.34 mm except
No. 120 2731 = shaft size: 3.0 mm

120 2738  68 x 58 x 66 mm  85 g

2240 57

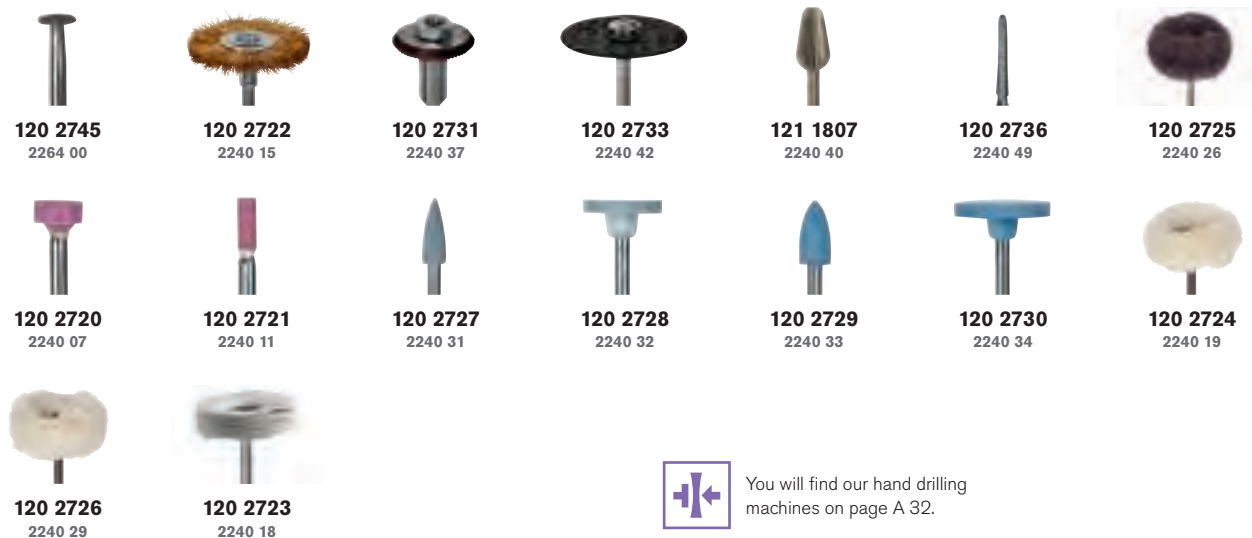

You will find our hand drilling machines on page A 32.



Shape	Application range	Size mm	Working speed rpm	Order No.
Grinder, wheel	To grind unhardened and alloyed steel	Ø 6 x 2.8	20,000–30,000	120 2720 2240 07
Grinder, cylindric	To grind unhardened and alloyed steel	2.5 x 6.5	20,000–30,000	120 2721 2240 11
Brass wire brush	To rework soldering joints	21 x 1.8	10,000	120 2722 2240 15
Silicone impregnated muslin wheel	To polish plastic materials	Ø 22	5,000	120 2723 2240 18
Wool buffing wheel	To polish plastic and ceramic	Ø 20	8,000	120 2724 2240 19
Flannel buffing wheel	To polish plastic and metal	Ø 20	5,000	120 2726 2240 29
Silicone burnisher, middle, pin	To work on metal, plastic and ceramic	4.5 x 12	7,000–10,000	120 2727 2240 31
Silicone burnisher, middle, wheel	To work on metal, plastic and ceramic	11 x 2	7,000–10,000	120 2728 2240 32
Silicone burnisher, fine, pin	For high gloss on metal alloy	5 x 10	7,000–10,000	120 2729 2240 33
Silicone burnisher, fine, wheel	For high gloss on metal alloy	14 x 2.5	7,000–10,000	120 2730 2240 34
Groove miller, facet	To rework frame grooves	17 x 2.8	2,000–4,000	120 2731 2240 37
Steel miller, bud shape	To work on metal, plastic and wood	Ø 6	8,000–12,000	121 1807 2240 40
Cutting wheel (10 pieces) inclusive mandrel	To cut metal and plastic	22 x 0.8	30,000	120 2733 2240 42
Diamond grinder, conical	For fine grinding and planing	Ø 1.6	30,000	120 2736 2240 49
Diamond miller	To groove rims of lenses	5 x 0.6	15,000–18,000	120 2745 2264 00
Trimming wheel, fine	For finishing metal, plastic and wood	Ø 25	10,000	120 2725 2240 26

Spiral Drill, HSS Special

- For drilling out steel screws, for drilling in Titanium as well as lens material such as CR 39 and transition lenses
- Designed for working on hard materials
- Extremely durable
- Working speed: **1,400 to 10,000 rpm**
- Field of application: **Plastic materials, polycarbonate, steel, Titanium and precious metal**
- Shaft size: **2.34 mm**
- These drills are also available as assortment No. 120 2566 (please see below)

120 2554–65  2 pieces

Order No.	Size
120 2554 2038 05	0.5 mm
120 2555 2038 06	0.6 mm
120 2556 2038 07	0.7 mm
120 2557 2038 08	0.8 mm
120 2558 2038 09	0.9 mm
120 2559 2038 10	1.0 mm
120 2560 2038 11	1.1 mm
120 2561 2038 12	1.2 mm
120 2562 2038 13	1.3 mm
120 2563 2038 14	1.4 mm
120 2564 2038 15	1.5 mm
120 2565 2038 16	1.6 mm



HSS Spiral Drill Set

- 12 high quality spiral drills No. 120 2554–65
- Contents:** 2 twist drills, each of sizes: 0.8, 1.0, 1.1, 1.2, 1.3 and 1.4 mm
- In a practical lid box set

120 2566
2038 50

 124 x 21 x 113 mm

 115 g

Spiral Drill, HSS

- With cylinder shaft, right cut
- Working speed: **500 to 3,000 rpm**
- Field of application: **Plastic materials and precious metals**

120 2515–29  3 pieces

Order No.	Shaft size	Size
120 2515 2032 05	0.5 mm	0.5 mm
120 2516 2032 06	0.6 mm	0.6 mm
120 2517 2032 07	0.7 mm	0.7 mm
120 2518 2032 08	0.8 mm	0.8 mm
120 2519 2032 09	0.9 mm	0.9 mm
120 2520 2032 10	1.0 mm	1.0 mm
120 2521 2032 11	1.1 mm	1.1 mm
120 2522 2032 12	1.2 mm	1.2 mm
120 2523 2032 13	1.3 mm	1.3 mm
120 2524 2032 14	1.4 mm	1.4 mm
120 2525 2032 15	1.5 mm	1.5 mm
120 2526 2032 16	1.6 mm	1.6 mm
120 2527 2032 17	1.7 mm	1.7 mm
120 2528 2032 18	1.8 mm	1.8 mm
120 2529 2032 20	2.0 mm	2.0 mm



HSS Spiral Drill Set, 30 pieces

- Contents:** 3 spiral drills, each of sizes: 0.5; 0.6; 0.7; 0.8; 0.9; 1.0; 1.1; 1.2; 1.3 and 1.4 mm
- In a practical lid box set

120 2530
2032 50

 210 x 18 x 113 mm

 140 g

Hard Metal Drill

- For drilling out steel screws stuck in hinges
- Working speed: **10,000 to 15,000 rpm**
- Field of application: **Steel screws**
- Shaft size: **2.34 mm**

120 2550–53

Order No.	Size
120 2550 2037 10	1.0 mm
120 2551 2037 12	1.2 mm
120 2552 2037 14	1.4 mm
120 2553 2037 16	1.6 mm



The drills No. 120 255 . are provided with a hard metal top. We recommend using less pressure and cooling.

Drill Miller for NIDEK

- For NIDEK CNC-machines ME and AHM
- Material: **Tungsten steel**
- Shaft size: **3.16 mm**

120 2687-88  10 pieces

Order No.	Size
120 2687 2209 08	0.8 mm
120 2688 2209 10	1.0 mm



Groove Miller

- To rework the groove of plastic and metal frames
- Shaft size: **2.35 mm**
- Diameter: **6 mm**
- Speed: **approx. 6,000 to 8,000 rpm**

120 2734
2240 44

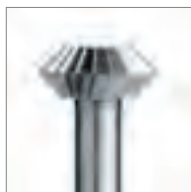

Groove Miller

- To rework the groove of plastic and metal frames
- Shaft size: **2.35 mm**
- Diameter: **8 mm**
- Speed: **approx. 6,000 to 8,000 rpm**

120 2735
2240 45



Hard Metal Drill for Plastic Lenses

- Polished surfaces guarantees a clean cut
- Working speed: **1,000 to 5,000 rpm**
- Field of application: **Plastic materials, polycarbonate and Trivex**
- Shaft size: **3.175 mm**

120 2531-45  38 mm

Order No.	Size	Order No.	Size
120 2531 2035 08	0.8 mm	120 2539 2035 16	1.6 mm
120 2532 2035 09	0.9 mm	120 2540 2035 17	1.7 mm
120 2533 2035 10	1.0 mm	120 2541 2035 18	1.8 mm
120 2534 2035 11	1.1 mm	120 2542 2035 19	1.9 mm
120 2535 2035 12	1.2 mm	120 2543 2035 20	2.0 mm
120 2536 2035 13	1.3 mm	120 2544 2035 21	2.1 mm
120 2537 2035 14	1.4 mm	120 2545 2035 22	2.2 mm
120 2538 2035 15	1.5 mm		



Hard Metal Drill Set for Plastic Lenses

- **Contents:** 10 drills (0.8; 0.9; 1.0; 1.1; 1.2; 1.3; 1.4; 1.6; 1.8 and 2.0 mm)
- Details: see drills above
- Incl. half-transparent plastic box

120 2549  86 x 10 x 53 mm  60 g



Hard Metal Miller for Plastic Lenses

- To notch and mill plastic lenses, polycarbonate and Trivex
- High quality double cut miller with **fishtail edge** for a clean cut and long life time
- Shaft size: **3.175 mm**

120 2700-07  38 mm

Order No.	Drillbit length	Miller size
120 2700 2212 08	8.0 mm	0.8 mm
120 2701 2212 09	9.0 mm	0.9 mm
120 2702 2212 10	9.0 mm	1.0 mm
120 2703 2212 11	9.0 mm	1.1 mm
120 2704 2212 12	9.0 mm	1.2 mm
120 2705 2212 13	9.0 mm	1.3 mm
120 2706 2212 14	9.0 mm	1.4 mm
120 2707 2212 16	10.0 mm	1.6 mm

double cut



You will find our drilling machines starting page A 28.

Drill and Miller Set for Plastic Lenses

- **Contents:** 6 drills (0.8; 1.0; 1.2; 1.4; 1.6 and 2.0 mm) plus 4 millers (1.0; 1.2; 1.4 and 1.6 mm)
- Details: See for example article 120 2531 and 120 2700

120 2547  86 x 10 x 53 mm  60 g



Drill Miller for Plastic Lenses

- This drill-miller has a polished surface which enables a clean cut
- Ideally suitable for perfect drilling and milling of plastic lenses, including polycarbonate and Trivex
- Material: **Tungsten steel**
- Shaft size: **3.14 mm**



120 2689-93  38 mm

Order No.	Drillbit length	Size
120 2689 2210 08	6.0 mm	0.8 mm
120 2690 2210 10	7.0 mm	1.0 mm
120 2691 2210 12	7.0 mm	1.2 mm
120 2692 2210 14	8.0 mm	1.4 mm
120 2693 2210 16	8.0 mm	1.6 mm



Drill Miller Set for Plastic Lenses

- **Contents:** 5 drill-miller (0.8; 1.0; 1.2; 1.4 and 1.6 mm)
- Details: see drill-miller above
- Incl. half-transparent plastic box

120 2694  86 x 10 x 53 mm  43 g

Diamond Spiral Drill

- For drilling glass and ceramic
- Working speed: **approx. 20,000 rpm**
- Shaft size: **2,34 mm**

120 2572-73

Order No.	Drillbit length	Size
120 2572 2044 10	7.0 mm	1.0 mm
120 2573 2044 12	9.0 mm	1.2 mm



Diamond Drill

- For drilling glass and ceramic
- Working speed: **15,000 to 18,000 rpm**
- Drillbit length: **6.0 mm**
- Shaft size: **2.34 mm**

120 2742  1.6 mm
2260 16



Diamond Wheel

- Shaft dimensions **22 x 0.60 mm**
- Working speed: **approx. 15,000 to 18,000 rpm**
- Shaft size: **2.35 mm**

120 2744
2263 00



Diamond Miller

- For milling of lenses
- Shaft dimensions: **5.0 x 0.6 mm**
- Working speed: **approx. 15,000 to 18,000 rpm**
- Shaft size: **2.35 mm**

120 2745
2264 00



Diamond drill No. 120 2742, 120 2743 plus diamond wheel No. 120 2744 and 120 2745 are high speed tools and should be operated with maximum speed. The optimum speed is between 15,000 and 18,000 rpm. Use **only water** as coolant. For minimum wear and tear and best performance apply low pressure only. Work in intervals and clean drill holes frequently. The **lower** the **rpm** of the diamond wheel/drill, the higher the wear and tear. The **faster** the **rpm** of the diamond wheel/drill, the better the working results.



Duplex Hinge and Temple Miller

- For working with joints and temples hinge rolls on Duplex temples
- Miller size: **3.0 mm**
- Shaft size: **3.0 mm**

120 2710 2217 03 | 35 mm



Double Cone Miller

- To mill a notch for rhinestones
- For deburring drilling holes in plastic lenses
- Can also be used for polycarbonate and Trivex
- Shaft size: **2.34 mm**

120 2746-49 | 44.5 mm



Core Miller

- For pre-milling of hidden hinge bowls
- Miller size: **5.0 mm**
- Shaft size: **3.0 mm**

120 2718 2237 50 | 23 mm



Order No.	Miller size
120 2746 2265 19	1.9 mm
120 2747 2265 23	2.3 mm
120 2748 2265 27	2.7 mm
120 2749 2265 40	4.0 mm

Screw End Miller

- Suitable for **steel**, brass and German silver screws
- Outer diameter: **1.8 mm**
- Inner diameter: **1.4 mm**
- Shaft size: **2.34 mm**

121 1806 2215 19 | 44 mm



Hard Metal Miller

- To work on metal and plastic
- Shaft size: **3.0 mm**
- Diameter: **6 x 48 mm**
- Speed: **approx 4,000 to 6,000 rpm**

120 2741 2243 00



Hinge Bowl Miller

- To mill out the hole for hinge
- 4 cuts
- Shaft size: **3.0 mm**

120 2713-17 | 35 mm



Long Hole Miller

- For milling long holes in plastic lenses
- Can also be used for polycarbonate and Trivex
- Shaft size: **2.35 mm**

120 2695-99 | 44.5 mm  2 pieces



Order No.	Miller size
120 2713 2236 30	3,0 mm
120 2714 2236 35	3,5 mm
120 2715 2236 40	4,0 mm
120 2716 2236 45	4,5 mm
120 2717 2236 50	5,0 mm

Order No.	Drillbit length	Miller size
120 2695 2211 08	3.5 mm	0.8 mm
120 2696 2211 10	4.0 mm	1.0 mm
120 2697 2211 12	4.2 mm	1.2 mm
120 2698 2211 14	4.5 mm	1.4 mm
120 2699 2211 21	5.1 mm	2.1 mm

Tool Holder



- With plastic handle and revolving plastic knob, especially for taps
- Clamping: **1.5 to 2.0 mm**

120 2592  90 mm  10 g
2062 00



Reamer Holder



- Brass, nickel-plated
- Clamping: **1.0 to 2.0 mm**

120 2593  80 x 6 mm  15 g
2065 00



Tool Holder

- With 2 exchangeable, hardened steel clamps, with square head
- Clamping: **0.7 to 1.0 and 1.4 to 2.4 mm**

120 2595  90 mm  25 g
2068 00



Precision Tool Holder

- 2 exchangeable steel clamps
- Black plastic handle with revolving knob
- **Second clamp accommodated in handle**
- Additional tools can be stored inside the handle
- Clamping: **0 to 1.5 and 1.5 to 2.5 mm**

120 2596  100 mm  37 g
2069 00



Precision Tool Holder

- With an extra large collet width
- For tools with a maximum shaft diameter of 3.2 mm
- Additional tools can be stored inside the handle
- Clamping: **2.5 to 3.2 mm**

120 2597  100 mm  34 g
2070 00



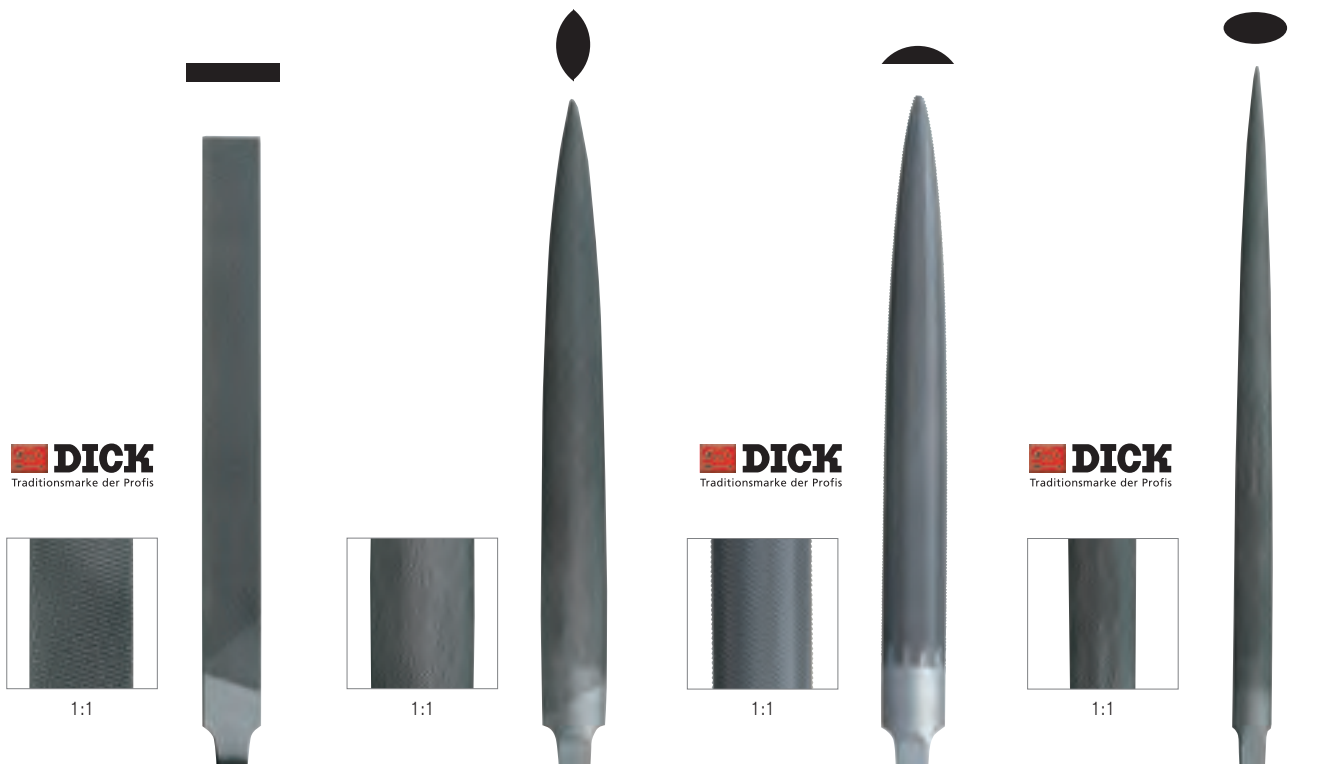

Precision File Flat, Large

- B & S special design
- With 2 different strokes: Cut 1 = rough and cut 3 = semi fine
- Narrow side without stroke
- Length of cut: 120 mm
- Suitable handles: No. 120 2310 and 120 2312

130 1411
1865 00

170 x 12 mm

40 g

3.2 mm

Precision File Lenticular

- Flat oval type with shaft
- Tapered pointed tip
- Cut: 2
- Length of cut: 125 mm
- Suitable handles: No. 120 2310 and 120 2312

120 2396
1870 12

175 x 15 mm

38 g

Precision File Half-round

- With shaft and pointed tip
- Length of cut: 125 mm
- Suitable handles: No. 120 2310 and 120 2312

120 2397 Cut: 1
1878 01
120 2398 Cut: 2
1878 02

175 x 13 mm

38 g

Precision File Oval

- Evenly vaulted
- With rounded edges
- For plastic material
- Cut: 3
- Length of cut: 150 mm
- Suitable handles: No. 120 2310 and 120 2312

120 2399
1882 13

205 x 9 mm

33 g

Swiss-made and exclusive to B & S.

At a quick glance the special quality of the 2 in 1 equalling file with its two different strokes cannot immediately be seen. A comparable quality is nowhere to be found.

Precision File Flat, Small, including Handle

- B & S special design
- With 2 different strokes: Cut 1 = rough and cut 3 = semi fine
- One third of one narrow side with stroke
- Delivered with plastic handle
- Length of cut: 100 mm



120 2395
1868 00

188 x 10 mm

32 g

2.8 mm



For cleaning we recommend our cleaning brush for files No. 120 4072 on page C 39 and E 32.

DICK
Traditionsmarke der Profis



DICK
Traditionsmarke der Profis

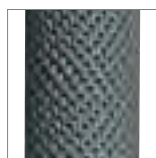

1:1



1:1



1:1



Raspel Half-round

- For working plastics
- With specially fine rasp cut No. 5
- Length of cut: 150 mm
- Suitable handles: No. 120 2310 and 120 2312

120 2400
1899 00

200 x 16 mm 55 g

Raspel Half-round

- For working plastics
- With rasp cut No. 5
- Length of cut: 135 mm
- Delivered with plastic handle

130 0688
1898 00

260 x 15 mm 118 g

Precision File Flat, Large

- With two different strokes: Cut 1 = rough and cut 3 = semi fine
- One third of the one narrow side with stroke
- Length of cut: 120 mm
- Delivered with plastic handle

130 0684
1866 00

240 x 15 mm 79 g

Filing Brush

- Flat
- Coated surface: 105 mm

120 4072
3516 00

250 x 35 mm

File Handles

- Lacquered wood
- Standard type, with collar
- Bore: 4 mm



120 2311 1732 90 90 mm 30 g

120 2310 1732 10 100 mm 35 g

File Handle, Plastic Red

- Reduces fatigue and avoids blisters
- Shaped to fit the hand, special design
- For file lengths from 100 up to 150 mm
- Material: High impact material with non-slip surface
- Bore: 4–7 mm, no opening up required



120 2312 1735 10 100 mm 34 g

File Handle, Plastic Blue

- Ergonomic file handle with soft touch surface
- Material: Two-component plastic
- Bore: 3.7 mm



120 2313 1735 80 85 mm 24 g

Needle File Assortment

- For work on plastic
- In plastic pouch, different shapes (flat, semicircular, trident, square type, round, flat with tapered tip)
- Cut: 2
- Length of cut: 70 mm

120 2382 | 140 mm | 6 pieces
1849 60



Needle File Assortment

- Notably small and handy version with **extra fine cut** for work with plastic
- In plastic pouch, different shapes (flat, semicircular, trident, square type, round, flat with tapered tip)
- Cut: 4
- Length of cut: 50 mm

120 2380 | 100 mm | 6 pieces
1848 50

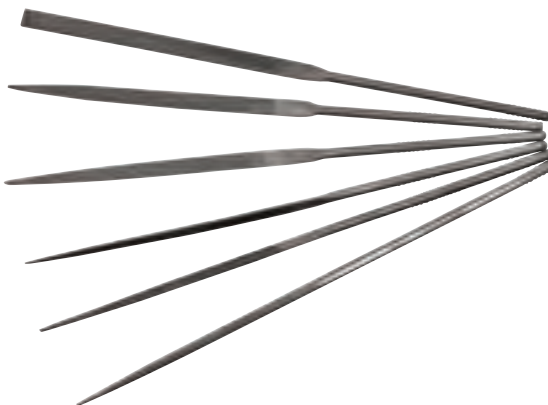

Needle File Assortment

- For work on plastic
- In plastic pouch, different shapes (flat, semicircular, trident, square type, round, flat with tapered tip, lenticular, knife-shaped)
- Assorted in cuts 1 and 3

120 2381 | 140 mm | 12 pieces
1849 00



Diamond Needle File Assortment

- For work on **steel, lenses, ceramic**
- In plastic pouch, different shapes (flat, trident, square type, round, flat with tapered tip, oval, biretta, lenticular, semicircular, knife-shaped)
- Length of cut: 50 mm

120 2360 | 140 mm | 10 pieces
1801 50



Needle Files

- Cut: 2

120 2383-86 | 140 mm | 2 pieces

120 2383 1849 61 round

120 2384 1849 62 flat

120 2385 1849 64 trident

120 2386 1849 67 knife shaped



Screw Head Slot File

- Without shaft
- Cut: 5
- Length of cut: 75 mm
- Thickness at edge: 0,30 mm



75 x 9 mm

0,55 mm

3 g

Lens Drill Hole and Hinge Files

- Round, cylindrical
- Cut: 3
- Length of cut: 100 mm



120 mm

1 g

109 6652
1860 15

120 2388 1.1 mm
1853 10
120 2389 1.3 mm
1853 13
120 2390 1.6 mm
1853 16

Pretty flexible.

No DIY store has this bench vice in its range. A bench vice with precise ball joint construction. Work pieces can be rotated and tilted exactly as required. The exchangeable jaws offer a secure and gentle grip. This German quality product is manufactured in small production runs –defining a typical B&S product.



Ball Joint Vice

- With lateral turning range and rotation 360°
- Perfect for all demands and requirements at work
- Jaw type: **Smooth and exchangeable**
- Clamping depth: **38 mm**
- Jaw width: **50 mm**
- Clamping range: **48 mm**
- Maximum thickness of working table: **80 mm**

120 2609 1.5 kg
2106 00

Plastic Jaws (without illustration)

- Suitable for No. 120 2609

120 2612 1 pair
2117 01

Vice

- Rotatable vice with steel jaws and trapezoidal threaded spindle
- Made of grey cast iron with table clamping clamp
- Jaw width: **50 mm**
- Clamping range: **50 mm**
- Clamping depth: **32 mm**
- Maximum thickness of working table: **50 mm**

120 2611 2 kg
2107 00



Ball Joint Vice

- Adjustable in all kind of work positions
- With rubber jaws
- Jaw width: **73 mm**
- Clamping range: **50 mm**
- Maximum thickness of working table: **55 mm**

120 2608 825 g
2105 30



Self-Adhesive Felt for Vice Jaws

- Can be cut to size, self-adhesive
- For vices to protect sensitive materials

120 2617 15 x 3 mm 1 m
2121 20



Aluminium Jaws

- For easy attachment, suitable for all vices

120 2616 65 x 10 x 14 mm 33 g 2 pairs
2121 15



Filing Vice

- For filing of temple stops with its clamp

120 2297 170 g
1724 00

Hack Saw

- Universal use (for metal and plastic)
- The handle is used to keep the blade under tension
- Perfect to use for special fretworks
- C shaped frame, including standard blade
- Bow depth: 65 mm

120 2666 | 295 mm
2152 00



Standard Blades for Hack Saw

120 2667 | 150 mm 10 pieces
2152 10



Fret Saw Working Set

- For wood and plastic
- **Contents:** 1 fret saw, 1 fret saw timber with clamp, 1 set saw blades

120 2665 390 g
2151 00

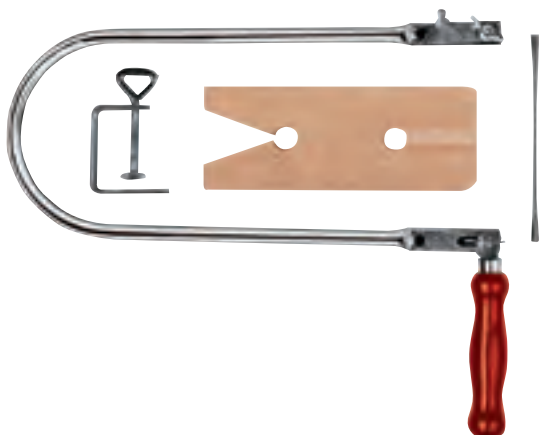

Fret Saw Timber (without illustration)

- With two clamps and metal sleeve

120 2669 220 x 14 x 90 mm 16 g
2160 00

Spare Screw Set (without illustration)

- Complete with washer and wing nut
- 1 set contains: 2 fly nuts, 2 washers and 2 screws

120 2668 9 g 2 pieces
2158 01

Spare Clamps (without illustration)

120 2670 2 pieces
2160 01

Fret Saw Blades

- For plastic, acrylic glass and non-ferrous metal
- One sided cut
- Length: 130 mm

120 2680-82 each 12 pieces

120 2680 0.8 mm **120 2682** 1.5 mm
2198 01 2198 03

120 2681 1.2 mm
2198 02



Fret Saw Blades

- For plastic
- All-over cut
- Length: 130 mm

120 2683-86 each 12 pieces

120 2683 0.8 mm **120 2685** 1.0 mm
2199 03 2199 05

120 2684 0.9 mm **120 2686** 1.2 mm
2199 04 2199 07



Fret Saw Blades

- For metal
- One sided cut
- Length: 130 mm

120 2677-79 each 12 pieces

120 2677 0.5 mm **120 2679** 1.0 mm
2196 01 2196 03

120 2678 0.7 mm
2196 02



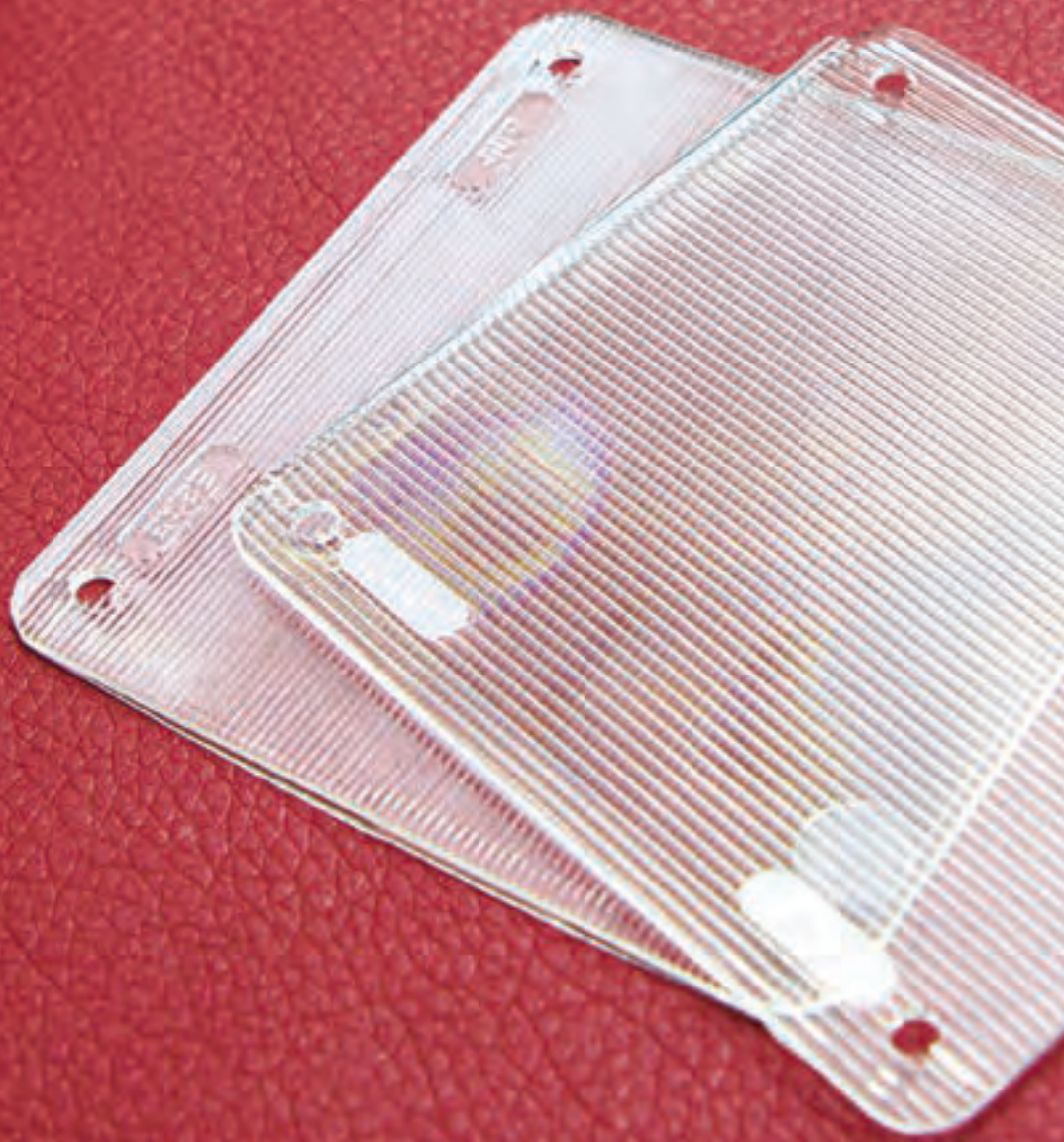



OPTOMETRY

Tools for the right diagnosis



- D 2 Trial Frames
- D 5 Trial Lens Sets
- D 8 Cross Cylinders and Test Strips
- D 10 Occluder & Colour Charts
- D 11 Tips & Tricks: Prism Foils
- D 12 Ophthalmic Lenses
- D 13 Stick-on Reading Segment
- D 14 Occluders
- D 15 Occlusion Foils
- D 16 Eye Patches Picolo
- D 18 Contact Lens Equipment
- D 22 Lens Clock and Thickness Gauge
- D 24 Caliper Gauges
- D 26 Tips & Tricks: The Cube
- D 29 Rulers

“Trial Frame Perfection” Trial Frame from Oculus; “Made in Germany” of course!



Hypo-allergenic plastic, easy to use and comfortable to wear; top workmanship gives this product its renowned quality.

Trial Frame from Oculus

- For trial lenses with diameter of 38 mm
- PD-Range 46 to 80 mm
- Adjustable bridge height and inclination
- Dermatologically safe material (**hypo-allergenic**)

UB6

- Use up to 12 trial lenses in total
- 2.5° steps for a better readability
- Flexible double temple tips for a perfect fit

120 5325
4428 00



For **spare parts** contact your local distributor.



Polarised Clip-on

For lateral mounting on the trial frame No. 120 5325.

120 5333 4428 50 Polarisation = Circular

120 5334 4428 51 Polarisation = V-position (45°/135°)

120 5333-34

1 pair (left and right)



Polarised Clip-on for Testing

Polarisation = V-position (45°/135°)

120 5470
4458 30



UB4

- Use up to 10 trial lenses in total
- Flexible and anatomic adjustable temple ends
- Trendy up to date design

120 5273
4423 00

 70 g

 For **spare parts** contact your local distributor.

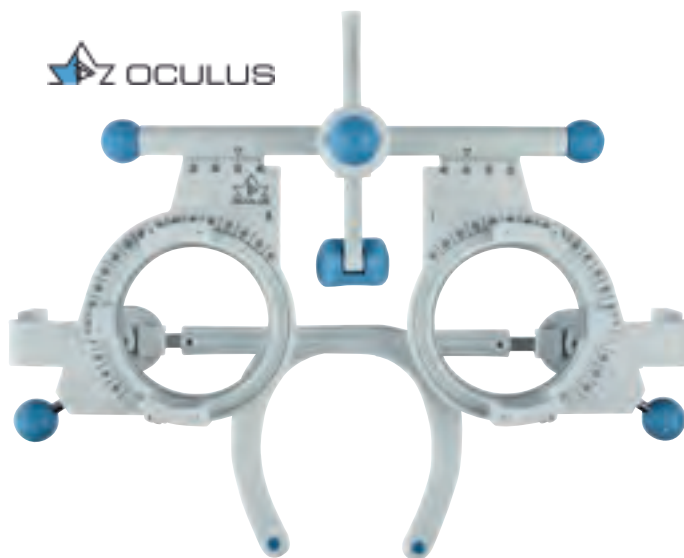

Polarised Clip-on

For lateral mounting on the trial frame No. 120 5273.
Polarisation = V-position (45°/135°)

120 5296
4423 51

 1 pair (left and right)





Polarised Clip-on

For lateral mounting on the trial frame No. 120 5273.
Polarisation = Circular

120 5295
4423 50

 1 pair (left and right)





Polarised Clip-on

- With plastic rims
- Diameter rim: 38 mm
- Diameter lens: 21 mm
- Polarisation: Circular
- Suitable for 3D sight testing

120 5469
4458 20

 1 pair (left and right)





Universal Trial Frame

- Use up to 10 trial lenses (Ø 38 mm)
- PD-range 50 to 80 mm
- Measuring device for vertex distance
- Temple inclination and length adjustable
- Bridge height and inclination adjustable at the same time
- Nose pads and temple ends have extra soft quality
- Incl. 2 nose pads, size S and M
- Colour: Black
- Delivered in B & S design box

120 5316 ●●● 61 g
4427 00

🔄 For **spare parts** contact your local distributor.



Universal Trial Frame

- With improved nose bridge
- Use up to 8 trial lenses (Ø 38 mm)
- PD-range 48 to 80 mm
- Measuring device for vertex distance
- Temple inclination and length adjustable
- Adjustable bridge height and inclination
- Nose pads and temple ends have extra soft quality
- Incl. 2 extra nose pads
- Colour: Black
- Delivered in B & S design box

120 5306 ●●● 80 g
4426 00

🔄 For **spare parts** contact your local distributor.



Universal Trial Frame

- Lightweight
- Holds 8 trial lenses (Ø 38 mm)
- PD-range 50 to 80 mm
- Temple inclination, length and bridge height are individually adjustable
- Colour: Charcoal grey
- Plastic storage box

120 5335 ●●● 52 g
4429 00

🔄 For **spare parts** contact your local distributor.



Trial Lens Set with 268 Trial Lenses with Metal Rims

- In high quality metal case
- Suitable for standard trial frames with 38 mm lenses
- All lenses are individually available

120 4913  54 x 10 x 35 cm  6.6 kg
4369 05

 For **spare parts** contact your local distributor.



Content of the Trial Lens Set

40 pairs each of plus and minus lenses:

- ± 0.12 dpt.
- ± 0.25 dpt. up to ± 6.00 dpt. in 0.25 increments
- ± 6.50 dpt. up to ± 10.00 dpt. in 0.50 increments
- ± 11.00 dpt. up to ± 14.00 dpt. in 1.00 increments
- ± 16.00 dpt. up to ± 20.00 dpt. in 2.00 increments

21 pairs each of plus and minus cylinders:

- ± 0.12 dpt.
- ± 0.25 dpt. up to ± 4.00 dpt. in 0.25 increments
- ± 4.50 dpt. up to ± 6.00 dpt. in 0.50 increments

14 prism lenses:



- 0.50 pdpt. (2 pcs) in 0.50 increments
- 1.00 pdpt. up to 4.00 pdpt. (2 pcs) in 1.00 increments
- 5.00 pdpt. up to 6.00 pdpt. (1 pc) in 1.00 increments
- 8.00 pdpt. up to 10.00 pdpt. (1 pc) in 2.00 increments

10 accessory lenses:

- 1x occluder/black
- 1x pinhole small
- 1x pinhole large
- 1x aperture slot
- 1x ribbed lens
- 1x crossline
- 1x plano lens
- 1x red
- 1x green
- 1x cross cylinder 0.25 dpt.

Trial Lens Set with 260 Trial Lenses with Metal Rims and AR-Coating

- In high quality metal case
- Suitable for standard trial frames with 38 mm lenses
- All lenses are individually available

120 4934  54 x 10 x 35 cm  6.6 kg
4369 10

 For **spare parts** contact your local distributor.



Content of the Trial Lens Set

39 pairs each of plus and minus lenses:

- ± 0.25 dpt. up to ± 6.00 dpt. in 0.25 increments
- ± 6.50 dpt. up to ± 10.00 dpt. in 0.50 increments
- ± 11.00 dpt. up to ± 14.00 dpt. in 1.00 increments
- ± 16.00 dpt. up to ± 20.00 dpt. in 2.00 increments

20 pairs each of plus and minus cylinders:

- ± 0.25 dpt. up to ± 4.00 dpt. in 0.25 increments
- ± 4.50 dpt. up to ± 6.00 dpt. in 0.50 increments

14 prism lenses:

- 0.50 pdpt. (2 pcs) in 0.50 increments
- 1.00 pdpt. up to 4.00 pdpt. (2 pcs) in 1.00 increments
- 5.00 pdpt. up to 6.00 pdpt. (1 pc) in 1.00 increments
- 8.00 pdpt. up to 10.00 pdpt. (1 pc) in 2.00 increments

10 accessory lenses:

- 1x occluder/black
- 1x pinhole small
- 1x pinhole large
- 1x aperture slot
- 1x ribbed lens
- 1x crossline
- 1x plano lens
- 1x red
- 1x green
- 1x cross cylinder 0.25 dpt.

Trial Lens Set with 260 Trial Lenses with Plastic Rims

- In high quality metal case
- Suitable for standard trial frames with 38 mm lenses
- All lenses are individually available

120 4936

4369 20

 54 x 10 x 35 cm

 5.5 kg

 For **spare parts** contact your local distributor.



Content of the Trial Lens Set

39 pairs each of plus and minus lenses:

- ± 0.25 dpt. up to ± 6.00 dpt. in 0.25 increments
- ± 6.50 dpt. up to ± 10.00 dpt. in 0.50 increments
- ± 11.00 dpt. up to ± 14.00 dpt. in 1.00 increments
- ± 16.00 dpt. up to ± 20.00 dpt. in 2.00 increments

20 pairs each of plus and minus cylinders:

- ± 0.25 dpt. up to ± 4.00 dpt. in 0.25 increments
- ± 4.50 dpt. up to ± 6.00 dpt. in 0.50 increments

14 prism lenses:

- 0.50 pdpt. (2 pcs)
- 1.00 pdpt. up to 4.00 pdpt. (2 pcs) in 1.00 increments
- 5.00 pdpt. up to 6.00 pdpt. (1 pc) in 1.00 increments
- 8.00 pdpt. up to 10.00 pdpt. (1 pc) in 2.00 increments

10 accessory lenses:

- 1x occluder/black
- 1x pinhole small
- 1x pinhole large
- 1x aperture slot
- 1x ribbed lens
- 1x crossline
- 1x plano lens
- 1x red
- 1x green
- 1x cross cylinder 0.25 dpt.

Trial Lens Set with 159 Trial Lenses with Metal Rims

- In high quality metal case
- Suitable for standard trial frames with 38 mm lenses
- All lenses are individually available

120 5082

4369 40

 52.5 x 6.8 x 30 cm

 5 kg

 For **spare parts** contact your local distributor.



Content of the Trial Lens Set

25 pairs each of plus and minus lenses:

- ± 0.25 dpt. up to ± 4.00 dpt. in 0.25 increments
- ± 4.50 dpt. up to ± 6.00 dpt. in 0.50 increments
- ± 7.00 dpt. up to ± 10.00 dpt. in 1.00 increments
- ± 12.00 dpt.

11 pairs each of plus and minus cylinders:

- ± 0.25 dpt. up to ± 2.00 dpt. in 0.25 increments
- ± 2.50 dpt. up to ± 3.00 dpt. in 0.50 increments
- ± 4.00 dpt.

8 prism lenses:

- 0.50 pdpt. up to 1.00 pdpt. (2 pcs) in 0.50 increments
- 2.00 pdpt. up to 5.00 pdpt. (1 pc) in 1.00 increments

7 accessory lenses:

- 1x occluder/black
- 1x pinhole
- 1x aperture slot
- 1x crossline
- 1x red
- 1x green
- 1x cross cylinder 0.25 dpt.

Upgrade Trial Lens Set, with 8 pcs of 0.12 dpt. Trial Lenses with Plastic Rims

- 1 pair of plus and minus lenses
- 1 pair of plus and minus cylinder
- Suitable for standard trial frames with 38 mm lenses
- All lenses are individually available

120 4977
4369 22

 22 x 2.5 x 12.5 cm

 114 g



Prism Trial Lens Set with Metal Rims

- Trial lens set upgrade, with 36 pcs prism lenses with power from 0.50 pdpt. up to 10.00 prism pdpt.
0.50 pdpt. (4 pcs)
1.00 pdpt. up to 6.00 pdpt. (4 pcs) in 1.00 increments
8.00 pdpt. up to 10.00 pdpt. (4 pcs) in 2.00 increments
- With 4 different base directions (45°/135°/225°/315°)
- Suitable for standard trial frames with 38 mm lenses

120 4935
4369 13

 24.5 x 9.5 x 17.5 cm

 1.4 kg



Prism Trial Lens Set with Plastic Rims

- Trial lens set upgrade, with 36 pcs prism lenses with power from 0.50 pdpt. up to 10.00 prism pdpt.
0.50 pdpt. (4 pcs)
1.00 pdpt. up to 6.00 pdpt. (4 pcs) in 1.00 increments
8.00 pdpt. up to 10.00 pdpt. (4 pcs) in 2.00 increments
- With 4 different base directions (45°/135°/225°/315°)
- Suitable for standard trial frames with 38 mm lenses

120 5019
4369 23

 24.5 x 9.5 x 17.5 cm

 1.2 kg



Everything at a glance.

Proven quality from Germany, very handy and light.



Cross Cylinder

With AR coating

∅ 25 mm 12 g

120 4784-85

120 4784 ± 0.25 dpt.
4367 20

120 4785 ± 0.50 dpt.
4367 40



Cross Cylinder

∅ 35 mm 25 g

120 5083-84

120 5083 ± 0.25 dpt.
4370 25

120 5084 ± 0.50 dpt.
4370 50



Power Testing Bar

With AR coating

Effect in diopters: Sph. ± 0.25 up to ± 0.50 dpt.

120 4783 ∅ 19 mm each 40 g
4366 05



Power Testing Bar

Effect in diopters: Sph. ± 0.25 up to ± 0.50 dpt.
Delivered in B&S Design Box

120 5088 ∅ 21 mm each 40 g
4373 00



Power Testing Bar Assortment



4 wooden bars in a matching wooden case.
Effect in diopters: Sph. ± 0.5 up to ± 3.5 dpt. and ± 4.0 up to ± 12.0 dpt.

120 5089 ∅ 21 mm each 50 g/bar
4373 50



Confirmation Test



Effect in diopters: Sph. \pm 0.25 dpt.

120 5087  35 mm each  25 g
4372 00



Binocular Confirmation Test Metal

Effect in diopters: Sph. \pm 0.25 dpt.
Adjustment of PD: 46 to 82 mm

120 5090  35 mm each  72 g
4374 00



Binocular Confirmation Test Plastic

Adjustment of PD: 44 to 81 mm

120 5094-95  35 mm each  37 g



120 5094 Effect in diopters: Sph. \pm 0.25 dpt.
4377 25

120 5095 Effect in diopters: Sph. \pm 0.50 dpt.
4377 50



Occluder

For cover test.
Total length: 24.5 cm

120 5091  6 cm  21 g
4375 00



LANG Fixation Cube

To be used for the cover test and motility test.

120 5096
4378 00



Ishihara Colour Chart

Book type, 14 charts.
Size: DIN A5



120 5536  250 g
4476 10

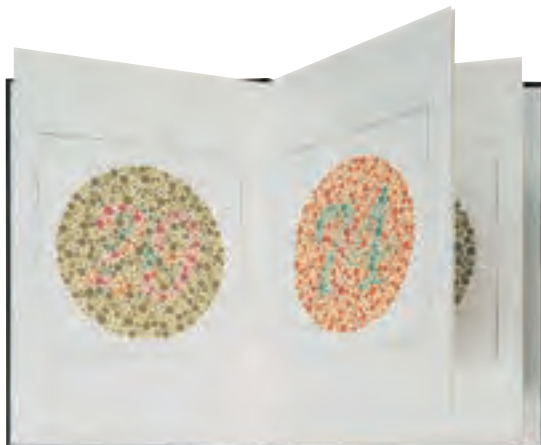

Matsubara Colour Chart for Children

Book type, 10 charts, incl. 6 matching plates.
Size: DIN A5



120 5537  275 g
4476 20



TIPS & TRICKS

ATTACH PRISM FOILS PROPERLY

Get the Right Base Position!

Prism Foils

No. 120 0806-120 0822

Scissors for Plastic

No. 121 0105

Foil Pen

No. 120 3049



approx. 2-3 minutes

This is how it works



1 UNPACKING



2 RECOGNIZING THE BASE



3 ATTACHING



4 MARKING



5 CUT OUT



6 MOISTEN



7 ATTACHING



8 SMOOTHING



TIP: Clean the foil only with water. Don't use any aggressive cleaning agents as the foil would lose its clearness!



ATTENTION: Storing period for lens foils max. 1 year. Please mark foils only with tallow or wax pencils!



3M Ophthalmic Lenses

- Prismatic additions for squint treatment
- Highly transparent material with perfect optical quality
- High flexibility, good adhesion and image quality
- Useful diameter: 66 mm

120 0806–22

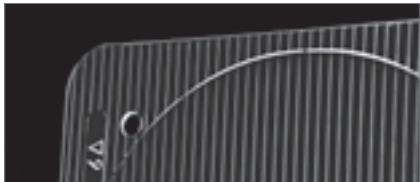

Ophthalmic Lenses

- Prismatic additions for squint treatment
- Useful diameter: 58 mm

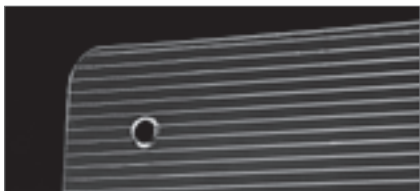

3M Lens Foils

- Spherical additions
- Highly transparent material with perfect optical quality
- Useful diameter: 66 mm
- Center thickness: 0.8 mm

120 0841–45

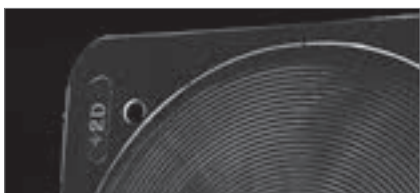

Order No.	cm/m	Order No.	cm/m	Order No.	cm/m
120 0806	1	120 0812	7	120 0818	20
0639 01		0639 07		0639 20	
120 0807	2	120 0813	8	120 0819	25
0639 02		0639 08		0639 25	
120 0808	3	120 0814	9	120 0820	30
0639 03		0639 09		0639 30	
120 0809	4	120 0815	10	120 0821	35
0639 04		0639 10		0639 35	
120 0810	5	120 0816	12	120 0822	40
0639 05		0639 12		0639 40	
120 0811	6	120 0817	15		
0639 06		0639 15			

Order No.	cm/m	Order No.	cm/m	Order No.	cm/m
120 0823	1	120 0830	7	120 0836	17.5
0640 01		0640 07		0640 17	
120 0825	2	120 0831	8	120 0837	20
0640 02		0640 08		0640 20	
120 0826	3	120 0832	9	120 0838	25
0640 03		0640 09		0640 25	
120 0827	4	120 0833	10	120 0839	30
0640 04		0640 10		0640 30	
120 0828	5	120 0834	12	120 0840	35
0640 05		0640 12		0640 35	
120 0829	6	120 0835	15		
0640 06		0640 15			

Order No.	Effect dpt.	Order No.	Effect dpt.
120 0841	+ 1.0	120 0844	+ 2.5
0646 10		0646 25	
120 0842	+ 1.5	120 0845	+ 3.0
0646 15		0646 30	
120 0843	+ 2.0		
0646 20			



Stick-on Reading Segment



Multiple application ...



... in protective goggles



... in sunglasses

Hydrotac

- Flexible plastic
- Reusable self adhesive
- Easy to handle

31 x 17 mm 1 pair

120 0796-801

120 0796	+ 1.25
0638 12	
120 0797	+ 1.50
0638 15	
120 0798	+ 1.75
0638 17	
120 0799	+ 2.00
0638 20	
120 0800	+ 2.50
0638 25	
120 0801	+ 3.00
0638 30	



Hydrotac Assortment

- 12 packets of reading segments
- 2 packets per diopter

12 pairs

120 0804
0638 99



3M

- Flexible plastic
- Reusable self adhesive
- Easy to handle

28 x 16 mm 1 pair

120 0790-94

120 0790	+ 1.00
0637 10	
120 0791	+ 1.50
0637 15	
120 0792	+ 2.00
0637 20	
120 0793	+ 2.50
0637 25	
120 0794	+ 3.00
0637 30	



Occluder

- Skin friendly, very elastic plastic
- Easy to adjust, with effective ventilation
- Strong small sucker

120 5341

4439 80

 75 x 50 mm  of the sucker 15 mm

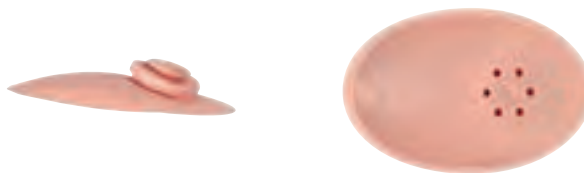



Occluder

- As No. 120 5341, but small and flat type

120 5343

4439 95

 55 x 45 mm  of the sucker 15 mm  3 pieces

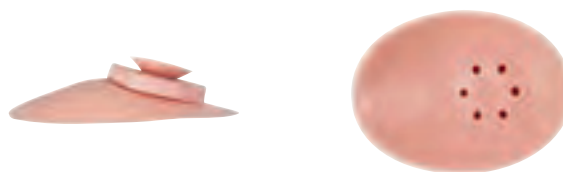

Eye Patches

Each eye patch comes with elastic strap.

100 7056

2055 01000

large, concave

 89 x 44 mm

100 7058

2055 11000

large, flat

 89 x 89 mm

100 7062

2055 31000

regular, flat

 76 x 44 mm



Side Protection Universal

- Silicone, to be cut to fit metal and plastic frames
- Mounted into the groove of the frame

 1 pair

120 1679

1316 00

Black

120 1680

1316 10

Semi-Transparent



Occlusion Foils in Different Types

Based on Prof. Bangerter and Prof. Lang, in graded transparency for reducing the vision.
For full, alternating or gradual occlusion note the instructions from the doctor.

Foils in Sheet Form

10 individual foils can be cut from one foil in order to equip 10 children's spectacles. The foils can be cut using scissors. A larger surface can be covered for special applications.

120 0851-62  215 x 105 mm

Order No.	Foil	Visus reduction	Order No.	Foil	Visus reduction
120 0861 0658 20	With motifs	Full	120 0852 0658 01	Colourless	0.1
120 0851 0658 00	Beige	Full	120 0853 0658 02	Colourless	0.2
120 0860 0658 10	Grey	Full	120 0854 0658 03	Colourless	0.3
120 0862 0658 30	Matt Black	Full	120 0855 0658 04	Colourless	0.4
120 0859 0658 09	Translucent	Light perception	120 0856 0658 06	Colourless	0.6
120 0857 0658 07	Colourless	< 0.1	120 0858 0658 08	Colourless	0.8



Single Foils

120 0863-72  60 x 60 mm

Order No.	Visus reduction	Order No.	Visus reduction
120 0863 0659 00	Full	120 0866 0659 03	0.3
120 0871 0659 09	Light perception	120 0867 0659 04	0.4
120 0869 0659 07	< 0.1	120 0868 0659 06	0.6
120 0864 0659 01	0.1	120 0870 0659 08	0.8
120 0865 0659 02	0.2	120 0872 0659 10	1.0



Single Foils with Funny Motives for Squint Treatment of Children

Visus reduction: Full

120 0873, -75, -76  60 x 60 mm

Order No.	Motifs	Order No.	Motifs
120 0873 0659 20	Ladybird	120 0875 0659 24	Clown
		120 0876 0659 25	Butterfly



Eye Patches Picolo 1 for Metal Frames

Soft eye patch for glasses, fits children aged 1–6 years.

- Non adhesive, no skin irritation
- 100% cotton
- Easy mounting on all metal frames
- Fits perfectly and encircles the eye softly
- Washable



 110 x 60 mm

130 0690–95

130 0690 Cars
0651 00



130 0691 Pink check
0651 01



130 0692 Blue check
0651 02



130 0693 Small hearts
0651 03



130 0694 Blue balls
0651 04



130 0695 Pink hearts
0651 05



Eye Patches Picolo 2 for Plastic Frames

Soft eye patch for glasses, fits children aged 1–6 years.

- Non adhesive, no skin irritation
- 100% cotton
- Easy mounting on all plastic frames
- Fits perfectly and encircles the eye softly
- Washable



 110 x 60 mm

130 0696-701

130 0696 Cars
0652 00



130 0697 Pink meadow
0652 01



130 0698 Green balls
0652 02



130 0699 Small hearts
0652 03



130 0700 Blue balls
0652 04



130 0701 Pink hearts
0652 05



12 Contact Lens Cases “Funny Animals”

– including presentation display

- Presentation display, dimensions (l x w x h): 211 x 147 x 30 mm

120 6164  12 contact lens cases including presentation display
7205 00

Every Funny Animal is available separately.

- 120 6165** 7205 01 Frog, Green
- 120 6166** 7205 02 Piggy, Pink
- 120 6167** 7205 03 Hippo, Grey
- 120 6168** 7205 04 Bear, Blue
- 120 6169** 7205 05 Fish, Purple
- 120 6170** 7205 06 Elephant, Yellow
- 120 6171** 7205 07 Monkey, Dark blue
- 120 6172** 7205 08 Owl, Dark purple

 8 pieces per colour



Standard Contact Lens Cases

- For soft and hard contact lenses
- Assorted colours (6x Blue white, 6x Green white)

120 6182  12 pieces
7250 00



- For hard lenses
- Assorted colours (3x Blue yellow, 3x Blue orange)

120 6184  6 pieces
7252 00



- With Microban® technology
- Continuous protection against the growth of microbes
- Assorted colours (6x Blue white, 6x Green white)
- For soft and hard contact lenses

120 6190  12 pieces
7256 00



- Hermetically sealed barrel cases with 2 baskets for soft lenses
- Assorted colours (3x Blue orange, 3x Orange blue)

120 6183  6 pieces
7251 00



Contact Lens Tweezers

- Small, handy to carry
- With silicone tips, especially gentle for soft contact lenses
- Assorted colours (4 x Green, 4 x Blue, 4 x White)

120 6185
7254 00  12 pieces



- Large type for an optimum handling
- With silicone tips, especially gentle for soft contact lenses
- Assorted colours (4 x Yellow, 4 x Dark blue, 4 x Dark green)

120 6186
7254 10  12 pieces



Contact Lens Suction Holder

- Hypoallergenic silicone, ok to combine with all standard cleaning solutions and care products
- Including hard case, easy to carry
- For hard lenses

120 6188
7255 00  12 pieces
Orange



120 6189
7255 10  12 pieces
Green



Hollow, for hard and
soft contact lenses

THERA°PEARL® Eye-ssential™ Mask

- Conforms to your face to deliver soothing relief from:
Dry Eyes,- Headaches/Sinus pain, Puffy Eyes & More!

THERA°PEARL®
A NEW DEGREE OF RELIEF™

120 6204
7293 00

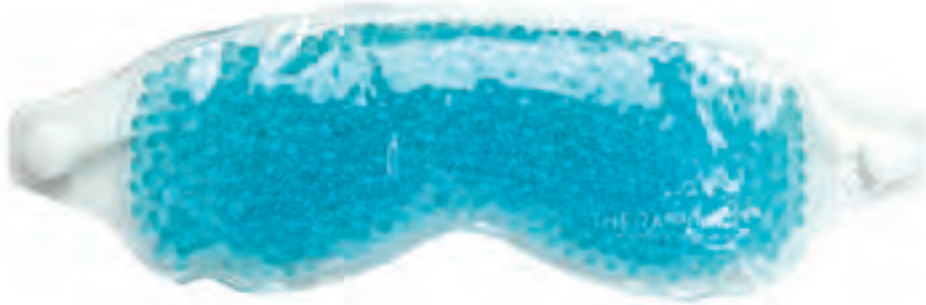



Lens Clock

- For all spheric and astigmatic lenses with **refractive index n 1.53**
- Measuring range: 0 to ± 20 dpt.
- Delivered in B & S Design Box

120 2788  62 g
2315 10



Lens Clock

- For all spheric and astigmatic lenses with **refractive index n 1.49 and n 1.60**
- Measuring range: 0 to ± 18 dpt.
- Delivered in B & S Design Box

108 0776  62 g
2315 20



Thickness Gauge

- With long arms and ball pointed measuring tips
- Arm depth: 75 mm
- Lens thickness: up to 20 mm
- Reading: 0.05 mm
- Delivered in a plastic box

109 2418  390 g
2314 00



Thickness Gauge

- Arm depth: 45 mm
- Lens thickness: up to 10 mm
- Reading: 0.05 mm
- Delivered in a plastic box

120 2793  75 g
2318 00



Digital Caliper Gauge

Electronic display "mm" and "inch" readings.
 Reading: 0.1 mm = 0.004 inch
 Battery: round cell 1.5 V
 Measuring range: 150 mm
 Jaw Depth: 40 mm

120 2798  315 g
 2335 00



Universal Caliper

Stainless steel, matt chrome.
 Reading: 1/50 mm and 1/1,000 inches
 Measuring range: 150 mm
 Jaw Depth: 40 mm

120 2799  170 g
 2337 02



Pocket Caliper

Made of high quality brass, offers 6 different measuring possibilities.
 Length: 100 mm
 Length of measuring leg: 40 mm

120 2797  65 g
 2333 10







Precision work

The B & S test lens with the central overprint of the marking provides a very accurate measurement. In addition the print colour chosen to increase contrast, makes it easier to read the values. The consistent quality of the printing is guaranteed by the German manufacturer.

B & S Test Lens

With milled centre holes, reference lines to mark the centre of the pupil and segheight, easy to use.
 Compatible with Rodenstock and Essilor systems.

120 2834  68 x 0.5 x 68 mm  200 pieces
 2359 02

120 2835  68 x 0.5 x 68 mm  50 pieces
 2359 04



Segheight Gauge

Transparent, scale printed in white.

120 2851  75 x 37 mm  2 pieces
 2371 02



A very special workplace:

To simplify the assembly and adjustment of spectacles. The magnetic surface helps to prevent screws and nuts from bouncing off. The aluminum edge gives a secure grip on the workbench and prevents slipping. The printed measurement lines makes determining the frame curvature easier and helps during the adjustment of the frame.

Magnetic Mat for Rimless Work

Work base for the workshop.

Ideal for aligning all frames, in particular when assembling rimless spectacles.

- The magnetic effect retains screws and nuts (minimises bouncing of small items when dropped)
- Measuring line system for determining the **frame curvature** on sunglasses and sports frames with extremely curved lenses
- Reference lines for aligning all frames
- Centration aid for determining the frame centre
- An aluminium edge prevents slipping of the mat and serves as support when tightening screws
- Centration aid for temple inclination
- Ruler
- Sizing template to find out the rough lens diameter
- Bold lines to check the markings

109 7625
2365 21

39,4 x 28 cm

800 g



TIPS & TRICKS
THE CUBE*3 at a Stroke*

The Cube
Art. No. 109 6994

 approx. 1 minute

This is how it works**OPTION 1:****1 ATTACHING****2 MARKING****3 CHECKING****4 CORRECT****OPTION 2:****1 MEASURE****OPTION 3:****1 MEASURE**

The marking tool “The Cube”

This innovative tool has been developed to combine 3 work steps in one: the simple and fast marking of spectacle lenses, the measuring of inclination and the checking of centering heights. The high-quality Staedtler pen included in the scope of delivery only has to be inserted through the tapered hole in the middle of the stylish acrylic block and off you go. Depending on which side the block is placed on, an assistant line can be drawn at four different heights in a flash and parallel. With the engraved ruler on one of the stand sides of the cube, the near part height of a bifocal lens, the progression height of a progressive lens or any other height can be measured. In addition, the Cube offers two scales for measuring inclination. It goes without saying that measurements can be taken from both the right and the left side of the temple.



The Cube

- For easy and quick marking of lenses
- For inclination measurements and inspection of the reading segment
- Including Staedtler Pen (Art. No. 120 3048)

109 6994
2372 50

 55 x 55 x 30 mm



Fine Line Ruler

To control the axis for uncut lenses, finished lenses and varifocal lenses.

120 2850  130 x 18 x 85 mm
2367 00



Axis Layout

According to DIN 58201, Aluminium, etched scale, formulas to determine prism on decentrated lenses on rear.
Measuring range: 0–170 mm

120 2860  175 x 1 x 90 mm
2377 00

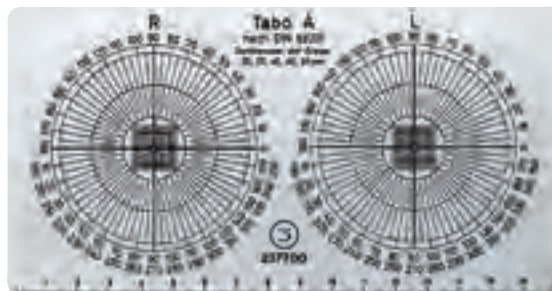

Formers

Plastic with scale on one side and cross hair on the other side, can be cut with paper scissors.

109 9802  71 x 1.5 x 65 mm  100 pieces
2395 30

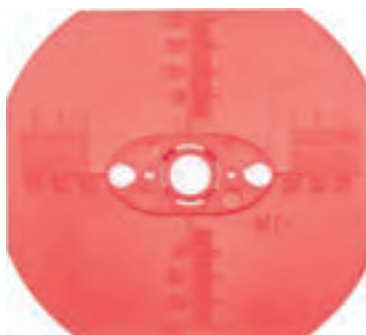



PD Ruler Transparent

Polycarbonate.

With holes to measure screw threads.

Measuring range: 0–160 mm (mm scale)

120 2855  205 mm  3 pieces
2373 00





PD Ruler

PVC.

With rear centering ring for nose bridges.

For simpler reading of markings.

Measuring range: 0–140 mm (mm scale)

120 2796  165 mm  2 pieces
2325 00



Multipurpose PD Ruler

According to Bremer, plastic, for total PD, monocular PD, segheight, bridge size and pantoscopic angle.

Measuring range: 0–145 mm (mm scale)

120 2859  155 mm
2376 00



PD Ruler

Plastic.

Measuring range: 0–170 mm (mm scale)

120 2858  180 mm
2374 00



Ruler Metal

Flexible, etched scale.

Measuring range: 0–150 mm (mm scale)

120 2795  165 mm
2320 01



Angle Measuring Device 180°

Metal.

Angle range: 0–180°

120 2849  45 x 174 mm
2366 00





CONSUMABLES

for first aid measures



- E 2 Lens Blocks and Adhesive Pads
- E 8 Lens Protection and Anti-Torsion Foil
- E 9 Anti-Foaming Agent and Abrasive Stones
- E 10 Lens Marking Pens
- E 11 UV Gel
- E 12 Glues and Screw Securing
- E 17 Oil and Cleaners
- E 20 Dyes
- E 22 Tips & Tricks: Plasti Dip
- E 24 Repair Colours and Repair Pens
- E 27 Tips & Tricks: Polishing
- E 28 Buffing Wheels and Brushes
- E 30 Polishing and Grinding Wax
- E 32 Marking and Emery Tools
- E 34 Solder and Flux



- 1 Lens Block
- 2 Adhesive Pad
- 3 Anti-Torsion Foil
- 4 Protection Foil (back of the lens)

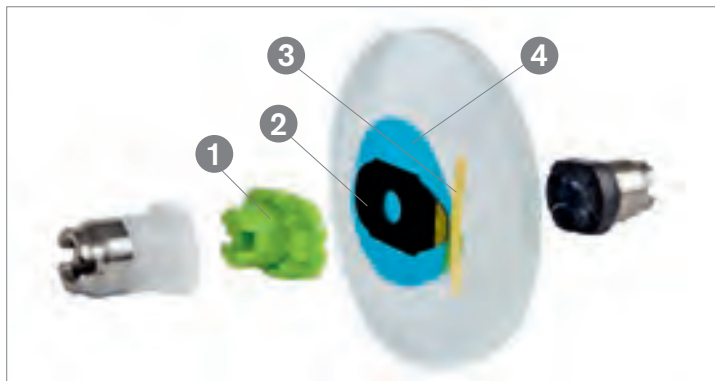

NIDEK Lens Block Pliable Cup

Flexible lens block for NIDEK machines with original NIDEK pick up.

Due to the larger surface of the lens block the risk of axis distortion is reduced.

Please use the matching B & S adhesive pads No. 120 2917, 120 2924, 120 2927, 120 2929, 120 2930, 120 2938, 120 2942 or 120 2949 only!

Up to curve 8.

∅ 30 x 17 mm  10 pieces



109 2405
3710 17N



109 2406
3710 17R
Red (left lens)



109 2407
3710 17G
Green (right lens)



109 2408
3710 50
Mixed colours for right and left lenses (5x red and 5x green)

For high curves **from base 8**.

∅ 30 x 17 mm  10 pieces



109 2409
3711 17

NIDEK Lens Block Mini Cup

Flexible lens block for NIDEK machines with original NIDEK Mini pick up. For small and flat shapes only.

Up to curve 6.

∅ 20 x 15 mm  10 pieces



109 2410
3714 15



109 2411
3714 15R
Red (left lens)



109 2412
3714 15G
Green (right lens)



109 2413
3714 50
Mixed colours for right and left lenses (5x red and 5x green)

NIDEK Lens Block Nano Cup

Flexible lens block for NIDEK machine LEX 1000.

For very small and flat shapes. To be used with the complete outer ring.

Please use the matching B & S adhesive pad No. 120 2923 only!

Up to curve 6.

∅ 30 x 17 mm/18 x 13.5 mm

10 pieces



109 2674

3715 13R

Red (left lens)



109 2675

3715 13G

Green (right lens)



109 2676

3715 13

Mixed colours for right and left lenses (5x red and 5x green)



Vario Block

Flexible plastic, for adhesive pads. Suitable for WEICO-system.

∅ 25 x 20 mm

∅ 25 mm

10 pieces

25 pieces



109 2414

3700 20

White

Flat curve

109 2416

3700 25

White

Flat curve



Adhesive pads should not be stored longer than 6–12 months depending on the material. Storage should be at room temperature (approx. + 18 °C) and with a humidity of approx. 30 %.



Adhesive Pads for Super Hydrophobic Lenses

- Material: Ethyl vinyl acetate foam
- Integrated anti-torsion foil
- In a dispenser box

± 0.9 mm  1 roll (500 pieces)



120 2942
2510 17



120 2943
2510 18



120 2944
2510 24



Order No.	Ø in mm	Adhesive power	Protection against axis slip	Type	for blocker
120 2942 2510 17	31 x 17	high, for super hydrophobic lenses	high, including anti-torsion foil	NIDEK	No. 109 2405-09
120 2943 2510 18	30 x 18			Universal	
120 2944 2510 24	24			Universal	

Adhesive Pads for Hydrophobic Lenses

- Material: Polyurethane foam
- In a dispenser box

 0.9 mm  see table



120 2928 2507 14



120 2929 2507 17
120 2930 2507 171



120 2931 2507 18
120 2932 2507 181



120 2933 2507 22
120 2934 2507 221



120 2935 2507 24
120 2936 2507 241

Order No.	∅ in mm	Adhesive power	Protection against axis slip	Type	for blocker	 (pieces)
120 2928 2507 14	21 x 14	very high, for hydrophobic lenses	very high	Universal		1 roll (500)
120 2929 2507 17	31 x 17			NIDEK	No. 109 2405-09	1 roll (500)
120 2930 2507 171	31 x 17			NIDEK	No. 109 2405-09	1 roll (1,000)
120 2931 2507 18	30 x 18			Universal		1 roll (500)
120 2932 2507 181	30 x 18			Universal		1 roll (1,000)
120 2933 2507 22	22			Universal		1 roll (500)
120 2934 2507 221	22			Universal		1 roll (1,000)
120 2935 2507 24	24			Universal		1 roll (500)
120 2936 2507 241	24			Universal		1 roll (1,000)

- Material: Polyurethane foam
- In a dispenser box

 0.9 mm  1 roll (1,000 pieces)



120 2949
2512 17



120 2950
2512 19



120 2951
2512 22



120 2952
2512 24

Order No.	∅ in mm	Adhesive power	Protection against axis slip	Type	for blocker
120 2949 2512 17	31 x 17	very high, for hydrophobic lenses	very high	NIDEK	No. 109 2405-09
120 2950 2512 19	30 x 19.5			Universal	
120 2951 2512 22	22			Universal	
120 2952 2512 24	24			Universal	



Adhesive Pads for Hydrophobic Lenses

- Material: Polyurethane foam
- In a resealable polybag

 0.9 mm

 10 strips (200 pieces)

120 2938
2508 17



120 2940
2508 24

Order No.	Ø in mm	Adhesive power	Protection against axis slip	Type	for blocker
120 2938 2508 17	31 x 17	high, for hydrophobic lenses	high	NIDEK	No. 109 2405-09
120 2940 2508 24	24			Universal	

Adhesive Pads for Standard Lenses

- Material: PVC film
- Comparable with 411 quality (thin very strong line)
- In a dispenser box

 0.38 mm

 see table

120 2917
2502 17



120 2918
2502 18



120 2919
2502 19



120 2921
2502 21



120 2922
2502 24



Order No.	Ø in mm	Adhesive power	Protection against axis slip	Type	for blocker	 (pieces)
120 2917 2502 17	32 x 17	high, for standard lenses	high	NIDEK	Nr. 109 2405-09	1 roll (1,000)
120 2918 2502 18	18			Universal		1 roll (1,000)
120 2919 2502 19	28 x 18			Universal		1 roll (500)
120 2921 2502 21	30 x 21			Universal		1 roll (500)
120 2922 2502 24	24			Universal		1 roll (1,000)

Adhesive Pads for Standard Lenses

- Material: Ethyl vinyl acetate foam
- 3M Leap III Adhesive Pads – the original 3M with double pull tabs
- In a dispenser box
- In a resealable polybag (120 2923)

 0.8 mm  see table



Order No.	∅ in mm	Adhesive power	Protection against axis slip	Type	for blocker	 (pieces)
120 2923 2503 13	31 x 17 18 x 13.5	very high, for standard lenses	very high	NIDEK Nano-Cup	No. 109 2674–76 (two-piece)	5 strips (100)
120 2924 2503 17	31 x 17			NIDEK	No. 109 2405–09	1 roll (1,000)
120 2925 2503 18	18			Universal		1 roll (1,000)
120 2926 2503 26	26			Universal		1 roll (1,000)

- Material: Polyolefin foam (120 2915 and 120 2916), Polyethylene foam
- In a dispenser box

 0.9 mm (120 2915)  0.8 mm  1 roll (1,000 pieces)

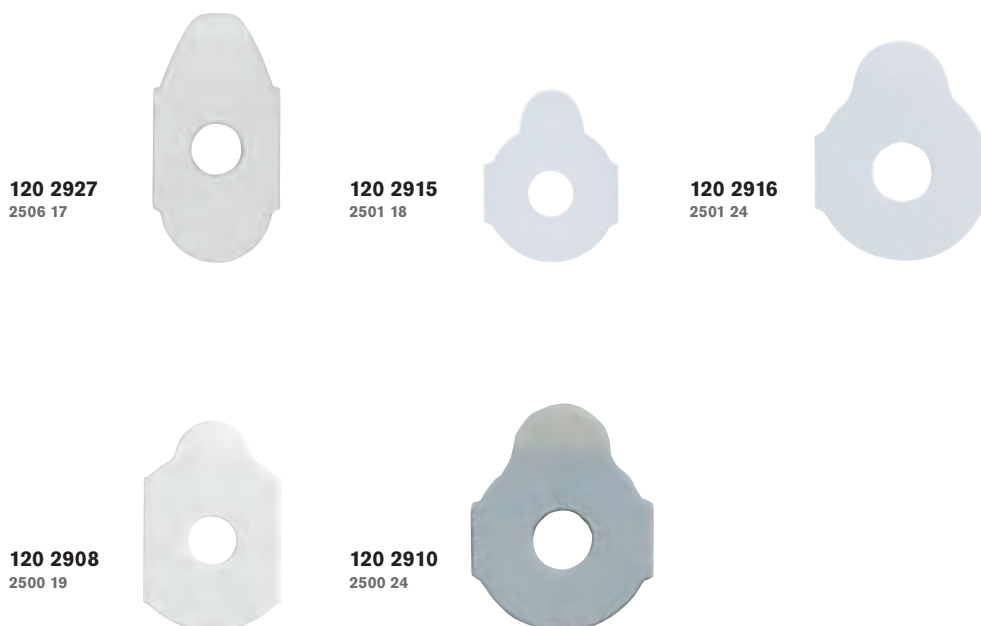

Order No.	∅ in mm	Adhesive power	Protection against axis slip	Type	for blocker
120 2927 2506 17	31 x 17	high, for standard lenses	high	NIDEK	No. 109 2405–09
120 2915 2501 18	18			Universal	
120 2916 2501 24	24			Universal	
120 2908 2500 19	30 x 18			Universal	
120 2910 2500 24	24			Universal	



Lens Protection and Anti-Torsion Foil

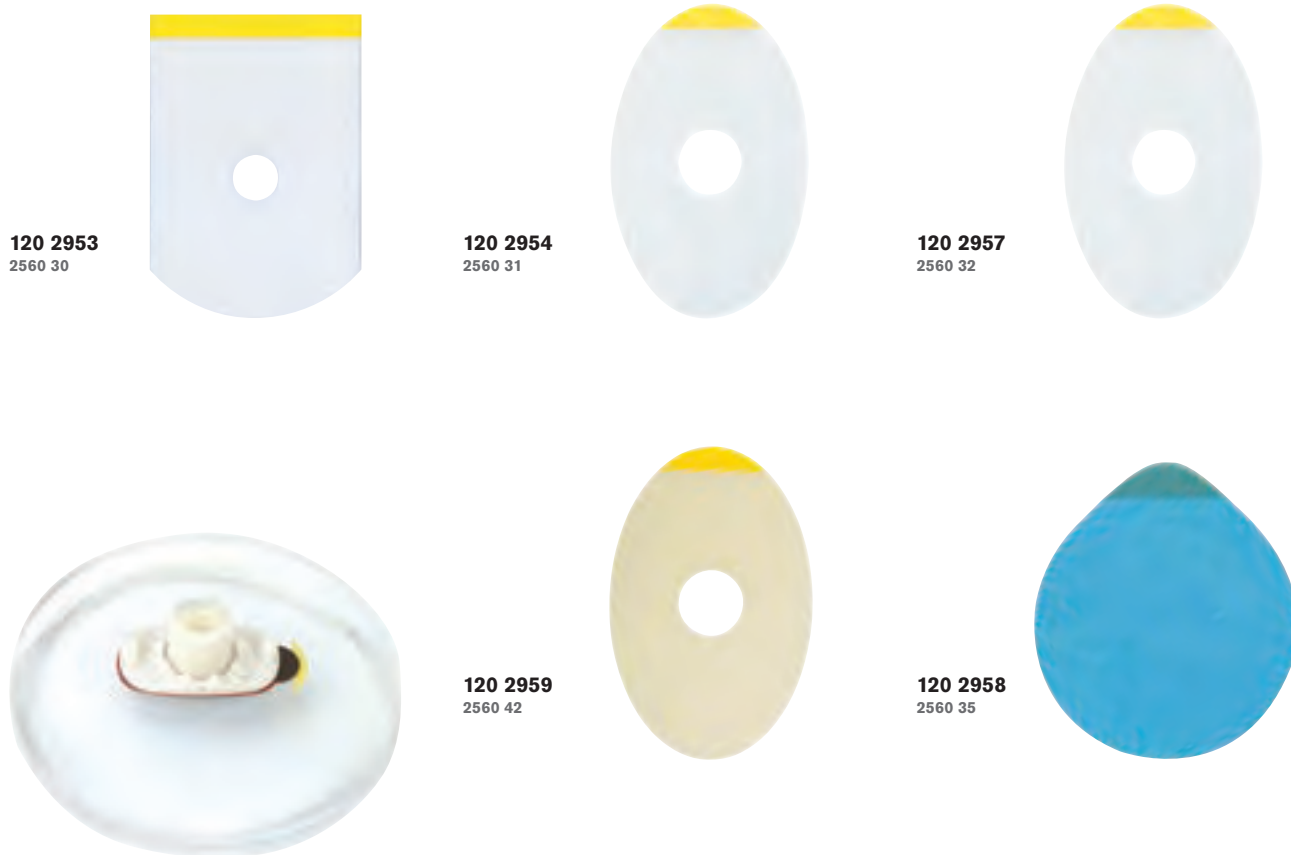

Order No.	Ø in mm	Product information	Field of application	📦 (pieces)
Anti-torsion foil				
120 2953 2560 30	40 x 28	To protect the front and back of the lens during the edging process. This protection foil is especially made for lenses with high-quality coatings. Storing period for adhesive pads: 6 months.	For lenses with + 4.5 dpt. on the front surface.	1 roll (500)
120 2954 2560 31	40 x 28	To protect the front and back of the lens during the edging process. This protection foil is especially made for lenses with high-quality coatings. Storing period for adhesive pads: 6 months.	For lenses with + 4.5 dpt. on the front surface. Oval shape for better handling!	1 roll (500)
120 2957 2560 32	40 x 26	For high curved lenses. To protect the front and back of the lens during the edging process. This protection foil is especially made for lenses with high-quality coatings. Storing period for adhesive pads: 6 months.	For lenses with high base curve. Especially flexible!	1 roll (500)
120 2959 2560 42	40 x 26	To protect the front and back of the lens during the edging process. The improved glue of the foil increases the adhesive power on all lenses with hydrophobic coatings. Storing period for adhesive pads: 6 months.	For lenses with + 4.5 dpt. on the front surface and hydrophobic lenses. Oval shape for better handling!	1 roll (500)
Lens protection				
120 2958 2560 35	35	To protect the back of the lens during the edging process.		1 roll (1,000)

Lens Grip

- Grip spray for lenses with hydrophobic and clean effect coatings
- Works additionally as a protective film to reduce the possibility of scratches and can be applied on the front and rear side
- Prevents axis slippage during the edging process
- Can easily be removed with conventional cleaning agents
- Dries quickly and is economical in use

120 2960 2562 00 📦 150 ml 📏 144 x 50 mm

120 2961 2562 10 📦 500 ml 📏 238 x 63 mm



Environmentally friendly Anti-Foaming Agent

The 100 % ecological compatibility of this item together with its high yield and effectiveness have earned it the B&S title of Top Product. Proving itself with its first use it does away with any annoying creation of foam during the grinding process. Another positive effect is the reduced corrosion of machine parts. Especially recommended by the B&S goes Green team.

Anti-Foaming Agent, blue

- Prevents foaming during grinding process
- Improves the grinding process
- Cools and protects machine parts from corrosion
- Improves overall care of the machine
- Reduces the build-up of grinding waste
- Rapid decline of dirt particles
- Has minimal aerosol development
- Contains no hazardous substances, is physiologically safe
- Very efficient (100 ml grinding additive for 20 litre water)



120 3859
3148 50

 500 ml

Bag Insert for Grinding Water Tank

Made of grey, tearproof plastic.

120 3398
2900 51

 800 x 560 x 0.06 mm  10 pieces



To prevent chemical reactions we recommend changing the water for the edger maximum every second week.



Abrasive Stones

- Colour: Red
- Type: Rough
- Granulation: 120
- Field of application: Diamond wheels of edgers

120 4017
3422 12

 110 x 12 x 25 mm  927 g  12 pieces



- Colour: White
- Type: Fine
- Granulation: 320
- Field of application: Diamond wheels of edgers



120 4018
3423 12

 100 x 13 x 25 mm  831 g  12 pieces



- Colour: Light blue
- Type: Very fine
- Granulation: 1,500
- Field of application: Diamond polishing wheel

120 4019
3424 01

 100 x 13 x 25 mm  80 g



Retractable Graphite Pencil

- Applicable to foils, spectacle lenses and even surfaces
- White is recommended for dark materials, especially for tinted lenses
- Refillable with leads No. 120 3044 and 120 3045

120 3042
2624 02



White



120 3044
2624 22



White

12 pieces

120 3043
2624 05



Red

120 3045
2624 55



Red

12 pieces

Lens Marking Pen

- Especially for lenses with clean effect coatings
- Light, water and abrasion resistant ink
- Dries quickly and can be removed with spirit alcohol
- Stroke width: 0.8 mm
- Tip: Round tip

120 3039
2620 02



White

2 pieces



Lens Marking Pen

- Especially for lenses with clean effect coatings
- Water resistant
- Remove colour with spirit alcohol
- In a patent-registered box
- Two types: Fine and super fine

120 3046
2625 01



Black, fine

4 pieces

120 3047
2625 05



Red, fine

4 pieces

120 3048
2627 01



Black, super fine

4 pieces



Universal Pen, fine

- Waterproof for permanent marking
- With dry safe function – pen can stay open for hours without running dry
- In a patent-registered box

120 3040
2623 01



Black

4 pieces

120 3041
2623 05



Red

4 pieces



Ink Remover Pen

The marking on lenses can be easily removed with this ink remover pen and can be used on **all types of lens material**.

120 3050
2630 00



Foil Pen

Water soluble, smudge-proof foil pen for occlusion foils, lenses and prism foils.

120 3049
2628 01



Black

2 pieces



Too large, wrongly drilled holes were yesterday

For sealing, for repairs or for repairing small blemishes – the UV fix gel is the indispensable helper of the optician. Curing by UV light, it can be used, among other things, for glazing and processing rimless frames which can be further processed when cured. Its high strength, crystal-clear colour, non-sticky surface and possible application to polycarbonate set it apart from other products of this kind, giving it the rating of top product.

Available as:

a) UV Fix Gel Applicator

- Perfect for delicate fittings
- Handy, convenient
- No air bubbles in the cannula

120 3940
3184 03

 3 ml



120 3940
3184 03

b) UV Fix Gel Application Bottle

- Convenient application bottle
- Reclosable
- With application tip for precise dispensing

120 3945
3184 10

 10 ml



Accessories: UV Fix Gel Inverted Holder

- UV fix gel is always ready for use and can be used up to the last drop
- Stable and perfect for immediate use
- No air bubbles in the cannula
- Supplied without application bottle

120 3944
3184 09

 40 x 65 x 50 mm

Proformic UV Glue

- Can be applied in several layers
- Cure with special developed and included LED
- Can be reworked in cured condition
- Colour after cure is transparent to slightly yellowish tint
- Solvent-free
- Delivered in a metal case

120 3956
3186 00

 4 g

Refill Cartridge

120 3957
3186 01

 4 g



You will find our UV lamps No. 120 2896 and 120 2894 on page A 40.



Instant Adhesive

Loctite 4850

- Superglue especially for **polycarbonate and Trivex**
- Stays flexible after curing
- Colour: Transparent

120 3894
3162 00  5 g

120 3895
3162 02  20 g



Loctite 460

- Superglue
- Also suitable for **polycarbonate and Trivex lenses**
- Colour: Transparent

120 3896
3162 10  20 g



VA 1460

- Medium viscous superglue
- Suitable for **polycarbonate and Trivex lenses**
- Less susceptible to liquids
- Colour: Transparent

Comparable with Loctite 460

120 3901
3165 10  20 g



Universal Adhesive

Loctite 401

- All-purpose adhesive
- Also suitable for **wood**
- Not suitable for polycarbonate and Trivex lenses
- Colour: Transparent

120 3897
3162 20  5 g



Loctite 454 Gel

- General purpose gel
- Ideal when non-drip application is required or for use on vertical or overhead surfaces
- Stays correctable for several seconds
- Ideally suited for applying **rhinestones**
- Not suitable for polycarbonate and Trivex lenses

120 3898
3162 30  3 g



VA 1401

- Medium viscous universal-adhesive
- Also suitable for **wood**
- Not suitable for polycarbonate and Trivex lenses
- Fast curing
- Colour: Transparent

Comparable with Loctite 401

120 3902
3165 20  4 g



Universal Adhesive

HG Power Glue

- The weld from the bottle
- 1 adhesive system with 4 different application possibilities: reinforcing, filling, forming and bonding
- Extremely cold & heat resistant and waterproof
- For 93% of all materials (plastics, wood, rubber, metal, glass, leather, stone etc.)
- Bonding point remains transparent and elastic without using the granulate
- No harmful solvents
- Colour: Transparent
- Viscosity of the adhesive: low



120 3903
3166 00

 5 g adhesive & 10 g granulate

120 3904
3166 01

 20 g adhesive & 40 g granulate

HG Power Glue

- For the pre-treatment of the surface to be bonded. Removes contaminants such as oil, grease, dust, rust, moisture, etc.
- Removes stubborn adhesive residues



120 3905
3166 10

 20 ml

HG Power Glue

- For the pretreatment of materials that are difficult to bond such as silicone, oily plastics (PP or PE)
- Closure cap with brush



120 3906
3166 20

 15 ml

HG Power Glue Activator

- Specially developed for HG Power Glue
- Very fast, bonding in seconds
- Closure cap with brush



120 3907
3166 30

 15 ml

Glass Glues

Loctite Glass Glue 3494

- Suitable for fixing correction lenses in diving masks
- Solvent-free and crystal clear one-component glue
- For glass and UV permeable plastics

120 3935
3181 30

 25 ml



Glass Adhesive

- To glue lenses into all types of frames, also to be applied as a liquid lining

120 3931
3177 00

 9 ml



Screw Grip

- To remove screws with a damaged head
- Immediate effectiveness (without curing)
- Simply wipe off after use

120 3908
3168 00

 20 g



- The filling level of the glues can vary due to the production process
- The details of the firmness refer to the usage of frame screws and can therefore differ to the manufacturers information



Plastic and All Purpose Glues

Super Glue

- Newly developed Pen-System which enables pen positioning
- Easy application, clean processing and improved dosing
- Area of application: **Plastics, rubber, metal, balsa wood, leather**
- Final strength after 24 hours
- Not suitable for polycarbonate and Trivex lenses

120 3948
3185 12

 12 g



Solvent for Glue

- Newly developed Pen-System which enables pen positioning
- Easy application, clean processing and improved dosing
- Solvent for all cyanoacrylate glues
- Short curing time
- Not suitable for polycarbonate and Trivex lenses

120 3951
3185 22

 30 g



Adhesive SICO MET 40

- Fast curing, solvent-free super glue with high flow rate
- Also suitable for **polycarbonate**

120 3954
3185 30

 20 g



Superglue Liquid

- Fast curing, solvent-free
- Versatile and economical to use
- Also suitable for **polycarbonate**

121 1718
3183 10

 10 g



VA 20

- Low-viscosity instant adhesive
- Fast curing, solvent-free
- Also suitable for **polycarbonate**

Comparable with SICO MET 40

120 3955
3185 40

 20 g



Screw Securing

Loctite 221

- Low firmness, solvent-free
- Colour: Red
- Also suitable in combination with **polycarbonate**

120 3890
3159 00  10 ml



Loctite 243

- High firmness, solvent-free
- Colour: Blue
- Also suitable in combination with **polycarbonate**

120 3892
3161 00  10 ml

120 3893
3161 05  50 ml



LOCK AN 302-21

- Newly developed Pen-System which enables pen positioning
- Easy application, clean processing and improved dosing
- Low firmness
- Colour: Red

Comparable with Loctite 221

120 3891
3160 00  20 ml



LOCK AN 302-43

- Newly developed Pen-System which enables pen positioning
- Easy application, clean processing and improved dosing
- High firmness
- Colour: Blue

Comparable with Loctite 243

120 3899
3164 00  10 ml

120 3900
3164 05  50 ml



Screw Fastener with Patented Dispenser Tip

- Low firmness
- Colour: Blue

120 3934
3178 00  10 g



- The filling level of the glues can vary due to the production process
- The details of the firmness refer to the usage of frame screws and can therefore differ to the manufacturers information



Stand for Mixing Bowl

120 1750
1406 00

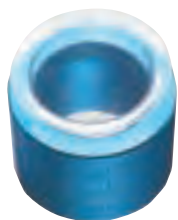

Mixing Bowl

120 1751
1407 00

∅ 21 mm

6 pieces



Application Tips made of Plastic

- For exact dispensing of screw fastener
- Inner diameter: 0.84; 0.5 and 0.41 mm

120 1744
1405 10

3 pieces



Application Tips

- Short metal tip for easy dispensing of super glue
- Long, flexible plastic tip can be shortened if tip becomes blocked
- Inner diameter: each with 0.84 and 0.25 mm

120 1749
1405 20

4 pieces



Plastic Bottle

- Material: LDPE
- Capacity: 1 l

120 1872
1488 03



Fluid Dispenser

- Fluid dispenser for acetone, petrol, alcohol, B & S special cleaner No. 120 3930 etc.
- Pump mechanism, can be used with one hand, reduces odour, plastic HDPE, with steel cover
- With pre-printed sticky labels
- Capacity: 125 ml



109 7359
1487 10

Fluid Dispenser

- Fluid dispenser for acetone, petrol, alcohol, B & S special cleaner No. 120 3930 etc.
- Pump mechanism, can be used with one hand, reduces odour
- PP material with plastic cover
- Capacity: 120 ml



110 0296
1489 00

3 pieces

Acetone

- To bond plastic frames
- To clean surfaces
- For plastic frames (no Optyl)

120 3923
3173 00

 100 ml



Special Cleaner for Spectacle Lenses

- Cleaner for polycarbonate, plastic and Trivex lenses
- Ideal for removing lens markings on progressive lenses
- Optimal dosage with B & S fluid dispenser No. 109 7359 and 110 0296

120 3929
3175 02

 250 ml

120 3930
3175 10

 1 l



Oil Dropper

- Body made of aluminum
- With single drop release
- Use for acid-free oil and also alkali oil
- Capacity: 5 ml

120 3055
2742 00

 145 mm

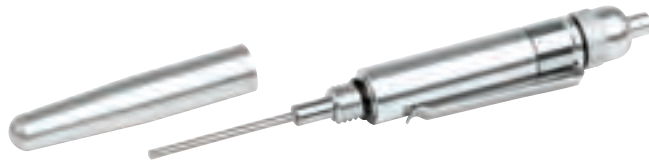

Oil

- For spectacle hinges, high quality, non-acidic

120 3920
3171 00

 20 ml



Compressed-Air Spray

Removes dust and fluff quickly and reliably from sensitive surfaces and parts which are not easily accessible.

Applications: Optics, instruments, medical technology, clock pieces, keyboards, hi-fi, videos, electrical equipment and model making

120 3927
3174 15

 400 ml



Silicone Spray Loctite 8021

Cleans and protects automatic grinders, machinery and equipment. Impregnates rubber, plastic and leather. Repels dirt and water, eases friction parts. Protects against corrosion and oxidation.

Important!

Do not allow spray to come into contact with spectacle lenses.

120 3926
3174 10

 400 ml



Silicone Care Spray

Cleans and protects grinding units, machines and devices. Impregnates rubber, plastic and leather. Dirt and water resistant. Eases friction on parts. Protects against corrosion and oxidation.

Beware!

Do not spray on lenses.

Comparable with Loctite 8021

120 3928
3174 20

 400 ml



OPTOCLEAN

Cleaning concentrate 1:20 for frames and lenses (also plastic lenses) in combination with ultra sound. Dilute with 20 parts water, rinse clean parts with running water and dry.

OPTOCLEAN is a very effective but mild cleaning solution which is suitable for cleaning sensitive materials such as polycarbonate and Trivex.

120 3885
3157 00

 1 l

120 3887
3157 25

 2.5 l



Cleaning Concentrate

Alkaline cleaning concentrate, 1:9 ratio; for extremely dirty metal frames, jewellery and other metal parts, for ultrasonic cleaners. The ammonia ingredient will brighten and freshen up the fine metals as well as coloured metals in an optimal way. The cleaned parts should be rinsed thoroughly under running water and then dried.

Do not use this cleaning solution on polycarbonate and Trivex lenses or other coated plastic lenses.

120 3888
3158 00

 1 l



You will find our Ultrasonic baths on page A 10 to A 12.





You will find our tinting unit Tinta 2 No. 120 3226 on page A 41.

Lens Dye Packets

- Water soluble dye powder for tinting lenses
- Ready prepared for 1 litre tinting solution
- The powder bag dissolves completely when mixed with hot water

 10 g



120 3009 2615 01
Black

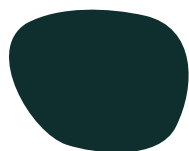

120 3012 2615 02
Grey green



120 3014 2615 04
Steel grey

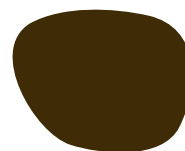

120 3016 2615 06
Brown

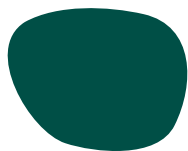

120 3018 2615 11
Dark green

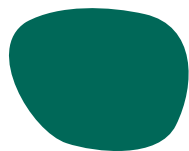

120 3020 2615 12
Green

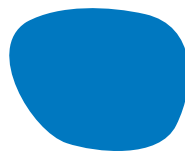

120 3021 2615 17
Blue



120 3023 2615 23
Fuchsia



120 3025 2615 24
Red

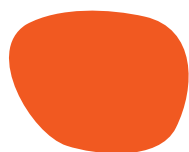

120 3027 2615 26
Orange

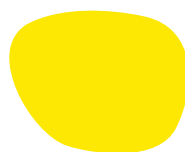

120 3028 2615 29
Yellow

UV Filter Additive

- Water soluble powder
- To apply an UV filter on lenses
- UV-protection to 400 nm
- Ready prepared for 1 litre tinting solution
- The powder bag dissolves completely when mixed with hot water



120 3030
2616 00

 35 g

Neutraliser

- Removes colour from tinted lenses

120 3036
2618 00

 1 l





TIPS & TRICKS

PLASTI DIP RUBBER COATING

Scratch Protection in a Twinkling of an Eye!

Plasti Dip

No. 120 3912, -14, -16

Thinner

No. 120 3910

Container, syringe, stirring spoon



approx. 5–10 minutes
without drying period



This is how it works

Option 1: Without thinner – for smooth surfaces (e.g. plier tips)

1 CLEANING



2 STIRRING



3 DECANT UNDILUTED



4 DIPPING



5 DRYING



Option 2: With thinner – for uneven surfaces (e.g. tip of the nose pad arm adjusting plier) | **Repeat step 1–3**

4 FILL THE SYRINGE



5 MIXING AND DIPPING



6 DRYING



TIP: To avoid bubbles don't shake the Plasti Dip, stir carefully. Undiluted Plasti Dip can be refilled into the Plasti Dip can. Diluted Plasti Dip can be stored in a lidded can.

Plasti Dip – Professional Protection whilst Adjusting Frames

Protects, gives grip and stays flexible

Plasti Dip – Multi-Purpose Synthetic Rubber Coating

- Can be used on metal, glass, stone and wood
- Air drying synthetic rubber coating
- Easy to apply by dipping or brushing
- Food safe in cured condition
- 24 hours curing time

Plasti Dip

120 3912, -14, -16  429 ml

120 3912
3169 20 Black
120 3914
3169 21 Blue
120 3916
3169 22 Red

Plasti Dip Thinner

120 3910  250 ml
3169 10



Repair Pens

With repair pens you can successfully:





- Repair scratches
- Cover solder or welding traces
- Can also be used to cover corrosion caused by perspiration



Usable for metal and plastic frames.



120 2998–3007

▪ Available in 10 colours:

Order No.	Colour	Code
120 2998 <small>2612 20</small>	Gloss black	
120 2999 <small>2612 21</small>	Matt black	
120 3000 <small>2612 22</small>	Dark blue	
120 3001 <small>2612 23</small>	Yellow gold	
120 3002 <small>2612 24</small>	Gunmetal	

Order No.	Colour	Code
120 3003 <small>2612 25</small>	Light silver	
120 3004 <small>2612 26</small>	Light brown	
120 3005 <small>2612 27</small>	Dark brown	
120 3006 <small>2612 28</small>	Protective lacquer clear gloss	
120 3007 <small>2612 29</small>	Protective lacquer clear matt	

Repair Pen Set

Consisting of 10 pens.

120 3008
2612 51



- Thoroughly clean the frame part to be repaired
- Shake the pen and press the tip in several times until you see the colour come through
- Put the colour on the required area
- Leave to dry for 10 to 20 minutes. Use a frame heater to dry quicker
- Not appropriate for paint coats that have received heat treatment



Repair Colours

Coloured quality lacquer for small repairs on frames, for example re-colouring after soldering. The colours may be mixed. The clear lacquer can be used for small repairs of protection lacquer and to optimise the colours.

120 2988 and 120 2990–96  12 ml



▪ Available in 7 colours plus clear lacquer:

Order No.	Colour	Code
120 2988 2611 00	White	
120 2990 2611 01	Black	
120 2991 2611 02	Metallic silver	
120 2992 2611 03	Metallic gold	

Order No.	Colour	Code
120 2993 2611 04	Blue	
120 2994 2611 05	Red	
120 2995 2611 08	Brown	
120 2996 2611 09	Clear Lacquer	

Repair Colour Set

Consisting of all 7 colours plus clear lacquer.

120 2997
2611 51







- Thoroughly clean frame parts to be repaired
- Shake the bottle well, you must be able to hear the ball bearing
- Apply the colour to the desired area
- Allow 6 hours to dry

Ink Paste

Permanent ink paste specifically developed to fill laser or pantograph engravings/decorations on plastic and metal frames. Apply the colour on the selected area with a putty knife to fill in the engravings. Remove excess material. Let dry at room temperature for 2–3 hours.

120 2969–72  10 g

Order No.	Colour	Code
120 2969 2609 00	Black	
120 2970 2609 01	White	
120 2971 2609 02	Gold	
120 2972 2609 03	Silver	











Lens Deco Pens

- To colour lens edges/surfaces and nylon threads
- Water-based and thus environmentally friendly
- For all materials including polycarbonate
- One pen will colour over 300 lenses
- Air dry for only 30 minutes
- Simply wipe off the colour with acetone or spirit with the exception of polycarbonate lenses



▪ Available in 8 colours:

Order No.	Colour	Code
120 2973 2610 21	Black	
120 2974 2610 22	Black matt	
120 2977 2610 25	Pink	
120 2978 2610 26	Grey	

Order No.	Colour	Code
120 2979 2610 27	Plum	
120 2981 2610 29	Light turquoise	
120 2984 2610 32	Blue	
120 2986 2610 34	Bordeaux	



Clean the lens edge thoroughly with lens cleaner No. 120 3929–30 or with an ultrasonic cleaning unit before application. For best results do not polish the lens edge. Shake the pen and gently push in the cartridge to fill with colour. For easy application attach the lens to a lens groover. Use lens cleaner No. 3175 00 to clean lens after application. Please screw cap on tightly after each use to prevent the pen from drying out.



TIPS & TRICKS

PERFECTLY POLISHED

*Buffing Wheel?
+ Polishing
Wax?
= The Combination
is Important!*



This is how it works

ACETATE, OPTYL, CELLULOID, PROPIONATE

ROUGH POLISHING

Grinding wax
No. 120 3850

Buffing wheel
No. 120 4002, 120 4033

FINE POLISHING

Polishing wax
No. 120 3849,
120 3851

Buffing wheel
No. 120 4002, 120 4033

HIGH GLOSS POLISHING

Burnishing wax
No. 120 3849, 120 3852,
120 3854

Buffing wheel, wool cone
No. 120 4030, 120 4031, 120 4032,
120 4073, 120 4074, 120 4076

POLYCARBONATE

LENS POLISHING

Polishing past
No. 120 3855

Felt cloth buff
No. 120 4028

CR 39, TRIVEX, PNX

ROUGH POLISHING

Polishing paste
No. 120 3854

Felt discs
No. 120 4025, 120 4026,
120 4027

FINE POLISHING

Polishing paste
No. 120 3854,
120 3855

Felt cloth buff
No. 120 4028, 120 4033

STEEL, WHITE AND PRECIOUS METALS

ROUGH POLISHING

Polishing wax
No. 120 3857

Buffing wheels
No. 120 4002, 120 4030, 120 4031,
120 4032, 120 4033

FINE POLISHING

Polishing wax
No. 120 3856

Buffing wheels
No. 120 4002, 120 4030, 120 4031,
120 4032, 120 4033

HIGH GLOSS POLISHING

Burnishing wax
No. 120 3854

Buffing wheel, wool cone
No. 120 4030, 120 4031, 120 4032,
120 4073, 120 4074, 120 4076

BAKELITE, HORN, CAOUTCHOUC, METAL

Polishing wax
without any wax

Leather buffing wheel
No. 120 4029



Felt Disc, conical shaped Soft Set Felt

- Core: Centered
- Bore Ø: 8 mm

∅ 100 mm |—| 20:5 mm

120 4025
3450 00



Felt Disc

- Core: Centered
- Bore Ø: 8 mm

∅ 100 mm |—| 25 mm

120 4026
3455 10



Felt Disc with Groove

- Core: Centered
- Bore Ø: 8 mm

∅ 100 mm |—| 25 mm

120 4027
3456 00



Felt Cloth Buff for Polycarbonate

To extend service life the red rings can be separated individually. The felt cloth buff in combination with the polishing wax

No. 120 3855, is perfectly suited for polishing Polycarbonate lenses – optimum speed for the treatment of Polycarbonate: approx. 1,500 rpm.

- Core: Plastic
- Bore Ø: Conical

∅ 80 mm |—| 25 mm

120 4028
3457 00



Leather Buffing Wheel

Is especially suitable for the final polishing of metal rubber, paladon, bakelite, horn etc.

Use the wheel dry **without** any polishing compound.

- Core: Plastic
- Bore Ø: Conical

∅ 90 mm |—| 6 mm

120 4029
3462 00



Muslin Buffing Wheel

- Core: Leather
- Bore Ø: 6 mm

∅ 125 mm |—| 12 mm

120 4030
3470 01



Muslin Buffing Wheel

- Core: Leather
- Bore Ø: 6 mm

∅ 125 mm |—| 24 mm

120 4031
3471 00

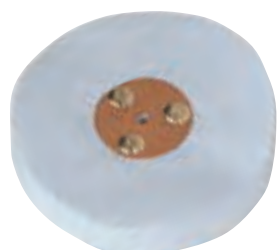

Flannel Buffing Wheel

- Core: Leather
- Bore Ø: 6 mm

∅ 125 mm |—| 30 mm

120 4033
3474 00

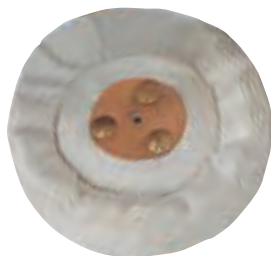

Silicone Impregnated Muslin Wheel

This silicone impregnated fabric structure offers significant advantages: it increases the life of the buffing wheel, due to elimination of fluff. They require less pressure during the polishing process and save 50 % on polishing paste.

- Core: Plastic
- Bore Ø: 6 mm

∅ 100 mm |—| 12 mm

120 4032
3472 00



Buffing Wheel

- Core: Plastic
- Bore Ø: 8 mm

∅ 100 mm |—| 10 mm

120 4002
3416 10

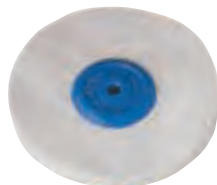

Wool Brush

- Core: Wood
- Bore Ø: 6 mm

∅ 70 mm |—| 35 mm

120 4073
3561 00



Wool Brush

- Core: Plastic
- Bore Ø: Conical

∅ 80 mm |—| 25 mm

120 4076
3582 00



Buffing Wool Cone

The buffing wool cone is manufactured in such a way that it can be mounted on a conical polishing tip. A different kind of fixing is not available. Due to the length of the axis unbalanced run may occur.

- Core: Wood
- Bore Ø: Conical

∅ 30:15 mm |—| 70 mm

120 4074
3571 00



 "Perfectly Polished" (see page E 27)



To ensure the buffing wool cone No. 120 4074 runs safely it's necessary to check if the cone can be screwed onto the polishing tip for at least 2 cm.



To prevent polishing buffs from fraying these can be napped before first use using a sharp object. However due to the properties of the material cotton cloth is not completely free of fluff.

For all buffing wheels with plastic core

Plastic cores have conical borings. While attaching to the polishing tip, the cone of the tip and the boring have to match.



Corresponding to the "European Safety Regulations for the correct use of grinding wheels" the following has to be observed:

1. Wheels with a total diameter of 100 mm or more have to be flanged $\frac{2}{3}$ on both sides.
2. The maximum running speed has to be observed.
3. During operation safety goggles (see Safety frames catalog) have to be worn.



Polired

120 3856
3143 00



Applications with approx. 2,800 rpm:	Buffing and smooth polishing: Cloth buffing wheels
Field of application:	Gold, steel
Weight:	approx. 60 g

Poligreen

120 3857
3144 00



Applications with approx. 2,800 rpm:	Buffing and smooth polishing: Cloth buffing wheels
Field of application:	Steel, platinum, silver
Weight:	approx. 60 g

Poliblu

120 3858
3145 00

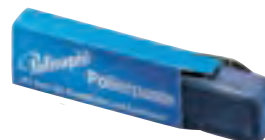

Applications with approx. 2,800 rpm:	Buffing and smooth polishing: Cloth buffing wheels	Buffing and smooth polishing: Cloth buffing wheels
Field of application:	Steel, platinum, silver	Plastic and caoutchouc rubber
Weight:	approx. 60 g	approx. 60 g

Burnishing Wax, yellow

120 3854
3126 00



Applications with approx. 3,500 rpm:	High gloss polishing: Cloth buffing wheels
Field of application:	Stainless steel, aluminum, metal, plastic
Weight:	approx. 500 g



Please take note of our small tools assortment including the silicone polisher No. 120 2738 on page C 31.

Grinding Wax, grey

120 3850
3120 00



Polishing Wax, blue

120 3849
3118 00



Applications with approx. 2,800 rpm:	Rough polishing: Cloth buffing wheels (approx. 2,300 rpm)	Buffing and smooth polishing: Wool wheels, cloth buffing wheels
Field of application:	Plastic	Plastic, optyl
Weight:	approx. 200 g	approx. 650 g

Burnishing Wax, beige

120 3851
3123 00



Burnishing Wax, beige

120 3852
3125 00



Applications with approx. 3,500 rpm:	Mirror gloss polishing: Wool wheels, cloth buffing wheels	High gloss polishing: Wool wheels
Field of application:	Plastic	Plastic
Weight:	approx. 200 g	approx. 200 g

Polishing Wax, blue, for Polycarbonate

The polishing paste is a high gloss polishing paste with "Diamantine" being perfectly suited for polishing **Polycarbonate lenses** as well as for the materials **Titanium, Platinum and Palladium**. The best polishing results will be achieved with the felt cloth **No. 120 4028** which has a patented conical flange (refer to page E 28).

120 3855
3127 00



Applications with approx. 2,800 rpm:	High gloss polishing: Felt cloth buffing wheel, wool wheels
Field of application:	Polycarbonate, Titanium, Palladium
Weight:	approx. 100 g



"Perfectly Polished" (see page E 27)



You will find our polishing motors
on page A 26 and A 27.

Abrasive Paper

120 3962-67  230 x 280 mm

 5 sheets

120 3962
3251 18 Granulation: 180

120 3963
3251 24 Granulation: 240

120 3964
3251 32 Granulation: 320

120 3965
3251 40 Granulation: 400

120 3966
3251 60 Granulation: 600

120 3967
3251 80 Granulation: 800

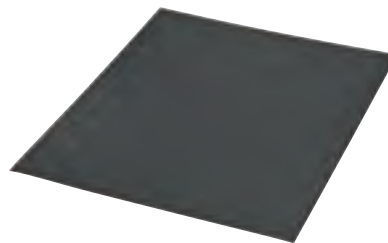

Abrasive Rubber

To clean solder points,
to dull metals and plastic.

120 4000-01  80 x 20 x 50 mm

120 4000
3412 02 Granulation: Medium

120 4001
3412 03 Granulation: Fine



Filing Brush (without illustration)

- Flat
- Coated surface: 105 mm

120 4072  250 x 35 mm
3516 00

Marking Needle

- With carbide tip
- Ballpoint pen format
- Sliding mechanism protects against injuries
- Metal grip to optimise the handling
- Spare tips available

Tips for Marking Needle (without illustration)

- Hard metal spare tips

121 1253  2 pieces
2302 30



121 0806  117 mm
2302 20



Accessories for Soldering and Welding Units

Gas Cartridge

- For handheld soldering unit No. 120 3081 and Micro Torch Set No. 120 3077 and 2762 00 (discontinued)
- Liquid gas
- Burning duration: approx. 3.5 h at low flame

120 3075  70 ml
2761 06



This is not liquid gas.
The cartridge lasts for approx. 45 minutes.

Oxygen Bottle

- For Micro Torch Set No. 120 3077 and 2762 00 (discontinued)
- Oxygen gas (no liquid gas)



120 3072  13 g
2760 02



Due to legal requirements gas and oxygen will be delivered in separate packaging.

Solder Dispenser

For Degussa solder No. 120 3829.
Opening: 1.8 mm

120 2591  200 mm  20 g
2059 00



Welding Wires for Laser or TIG Welding

Silver Palladium Wire

Only for use with spectacle frames with **nickel content, such as monel or German silver.**
Material strength: 0.4 mm

120 3842  2 x 25 cm
3043 30



Titanium Wire

Only for use with **titanium frames.**
Material strength: 0.3 mm

120 3841  2 x 25 cm
3043 10



Electrolyte

120 3958
3198 00  800 ml



Flux

120 3960
3199 01  1 l



Heatstop

- Isolating paste for all types of soldering
- Prevents the distribution of heat in metal
- Consistency: Paste

120 3838
3029 00  100 g



BrazeTec h 80 Flux

- For difficult to process materials, such as **stainless steel**
- Leaves no residue on the soldered area
- Consistency: Paste

120 3847
3114 00  100 g



BrazeTec h Flux

- Consistency: Paste

120 3844
3112 00  100 g

120 3846
3112 05  500 g



If dried out, welding flux and heat stop can be sprayed with distilled water.

Silver Solder, white fluid

- For jewellery and frames
- To use without additional flux
- Metal contents: 56 % Ag
- Melting point: 650 °C
- Form: Paste in a dispensing cartridge

120 3813
3002 00  8 g



white fluid, flux included



You will find our soldering unit No. 120 3092 and further accessories on page A 33 to A 35.



Solder

Hard Solder silver

120 3828
3003 00



Silver Solder Degussa 600 L 3

120 3829
3007 00



Field of application:	Bronze, nickel, stainless steel	Jewellery
Metal contents:	60 % Ag without Cd	60 % Ag without Cd
Melting point:	680 °C	680 °C
Recommended Flux:	120 3844, -46 BrazeTec h	120 3844, -46 BrazeTec h
Form:	0.5 mm wire Ø	0.4 mm wire Ø in dispenser
Sales unit:	5 g	2 g
Length:	approx. 230 cm	approx. 110 cm

Silver Solder Degussa 6002 without Cd

120 3830
3008 00



Phantom Solder

120 3831
3010 00



Field of application:	Jewellery	For practice, also suitable for nickel-free material
Metal contents:	60 % Ag, 23 % Cu, 14.5 % Zn, 2.5 % Sn	55 % Ag, Sn
Melting point:	680 °C	660 °C
Recommended Flux:	120 3844, -46 BrazeTec hh	120 3844, -46 BrazeTec h
Form:	0.5 mm wire Ø	0.5 mm wire Ø in dispenser
Sales unit:	5 g	3 g
Length:	approx. 280 cm	approx. 130 cm

Solder wire, white fluid

120 3832
3014 00

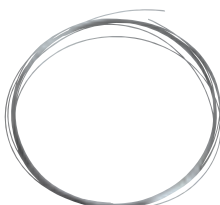

Field of application:	All silver alloy over 800 ‰ fineness
Metal contents:	675 ‰ Ag
Melting point:	710 °C
Recommended Flux:	120 3844, -46 BrazeTec h
Form:	0.4 mm wire Ø
Sales unit:	5 g
Length:	approx. 230 cm

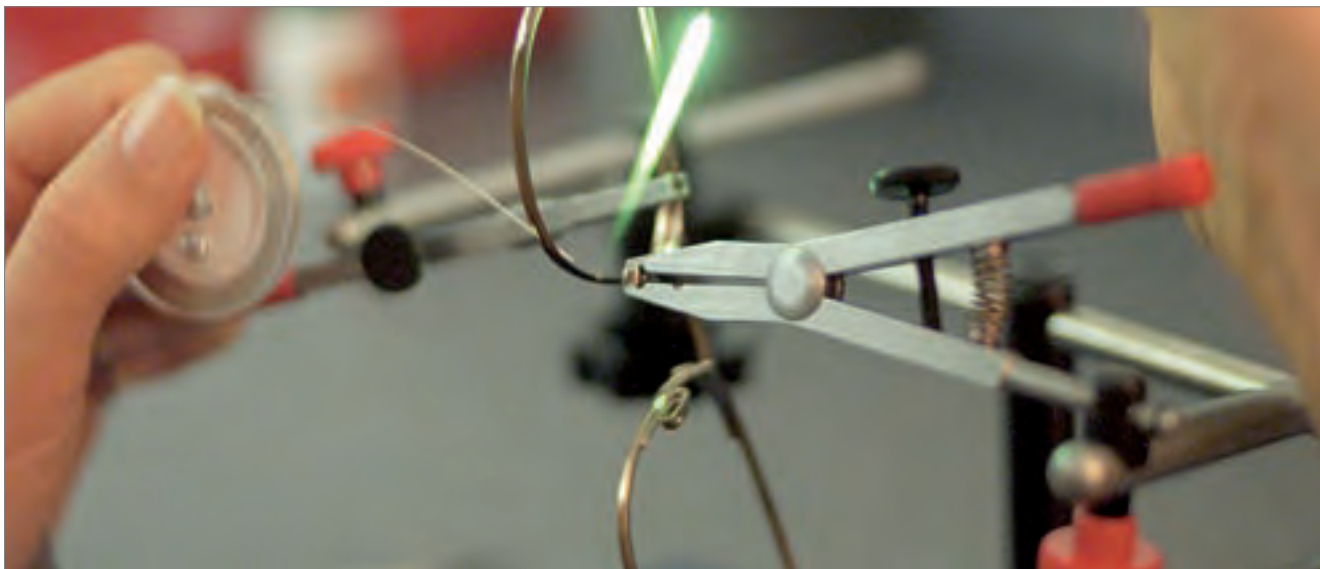

Gold Solder, 8 Ct

120 3834
3016 00



Solder Wire, yellow fluid

120 3833
3015 00



Field of application:	Jewellery and metal frames of gold allo	All standard metals such as silver, nickel, chrome, stainless steel, brass, etc.
Metal contents:	333 ‰ Au	55 % Ag, 21 % Cu, 22 % Zn, 2 % Sn
Melting point:	590 °C	660 °C
Recommended Flux:	120 3844, -46 BrazeTec h	120 3844, -46 BrazeTec h
Form:	Wire 0.5 mm Ø	Wire 0.4 mm Ø
Sales unit:	1 g	5 g
Length:	approx. 70 cm	approx. 75 cm

Pallarium – Universal Solder, white fluid

120 3836
3023 00



white fluid, flux included

Pallarium – Universal Solder, gold fluid

120 3837
3023 01



gold fluid, flux included

Field of application:	All standard metals such as nickel, silver, chrome, stainless steel, gold, brass and others	All standard metals such as nickel, silver, chrome, stainless steel, gold, brass and others
Metal contents:	45 % Ag	33 % Ag
Melting point:	580 °C	620 °C
Recommended Flux:	Without flux	Without flux
Form:	Tube 1 mm Ø	Tube 1 mm Ø
Sales unit:	12 rods at 150 mm each	12 rods at 150 mm each







SPECTACLE FRAME PARTS

in exact dosage with targeted effect



- F 2 Overview: Nose Pads
- F 10 Tips & Tricks: Silicone Nose Pads Minifits
- F 15 Nose Pad Cushions
- F 16 Tips & Tricks: Self-adhesive Nose Pad Cushion
- F 18 Tips & Tricks: Nose Pad Arms
- F 19 Nose Pad Arms
- F 22 Overview: Screws and Nuts
- F 35 Tips & Tricks: 4-in-1 Screws
- F 49 Nuts, Washers and Sleeves
- F 54 Hinges
- F 58 Overview: Temples and Temple Ends
- F 66 Tips & Tricks: Sport Temple Ends
- F 75 Long Temple Ends
- F 76 Tips & Tricks: Heat Shrink Tube
- F 78 Temples
- F 81 Spare Parts for Rimless Frames with Sleeves Mounting
- F 84 Lens Washer
- F 85 Nylon Threads
- F 86 Exercise Samples for Trainees



The B&S Nose Pad Range:

- Extensive selection
- For all applications
- Easy to find. Simple to order



Ordering in 3 Steps

1. Select the material (content on the right)
2. Select size and shape
3. Select mounting type

Mounting Systems



Push-in
System



Screw-in
System



Screw-in AND
Push-in System

Worth Knowing

f&w & The Icons guarantees:

- High-quality basic materials
- Maximum durability and optical transparency
- Colour stability
- No flashes

frey & winkler
CREATIVE SILICONE PRECISION

f&w Premium Nose Pads Made in Germany offers:

- Silicone pads made of medical silicone for highest transparency
- PVC nose pads without phthalate containing plasticiser
- Small cast points for better wear comfort
- Rounded edges
- High dimensional accuracy and high quality of the composite materials
- Certified according to DIN EN ISO 9001 and 13485

Logic[®]









Smart, Universal Nose Pads

U.S. Patent No. 5,872,612

Hilco Pads Logic[®]:

- Patent nose pads, suitable for screw-in AND push-in systems
- Premium anti-slip-silicone
- Reduces the nose pad stock by up to 50 %





Overview for Simple Selection

	<p>Silicone Nose Pads</p> <ul style="list-style-type: none"> ▪ Symmetrical Nose Pads ▪ Ultra Slim, Symmetrical Nose Pads ▪ Round and Classic 	<p>F 4 F 4 F 5</p>
	<p>Comfort Nose Pads</p> <ul style="list-style-type: none"> ▪ Air Active 	<p>F 6</p>
	<p>Silicone Nose Pads and TPE Pads</p> <ul style="list-style-type: none"> ▪ Saddle Bridges ▪ "System 3" ▪ Primadonna System ▪ Air Titanium and Minimal Art 	<p>F 7 F 7 F 8 F 8</p>
	<p>PVC Nose Pads, Medium Soft</p> <ul style="list-style-type: none"> ▪ Primadonna System ▪ Air Titanium and Minimal Art ▪ With Plastic Insert ▪ With Metal Insert 	<p>F 8 F 8 F 9 F 9</p>
	<p>Polycarbonate Pads, Hard</p> <ul style="list-style-type: none"> ▪ Ultra slim 	<p>F 11</p>
	<p>Special Nose Pads and Nose Bridges</p> <ul style="list-style-type: none"> ▪ Nose Pads for Special Applications ▪ Nose Pads for ic! berlin Frames ▪ Logic® ▪ Silicone Nose Bridges ▪ Nose Pads for Ray Ban Frames 	<p>F 11 F 11 F 12 F 12 F 14</p>
	<p>Hypo-allergenic Special Nose Pads</p> <ul style="list-style-type: none"> ▪ PCTG ▪ Titanium 	<p>F 12 F 13</p>
	<p>Nose Pad Cushion</p> <ul style="list-style-type: none"> ▪ Sponge ▪ Silicone 	<p>F 15 F 16–F 17</p>
	<p>Nose Pad Arms</p> <ul style="list-style-type: none"> ▪ For Plastic Frames ▪ For Metal Frames 	<p>F 18–F 20 F 21</p>
<p>Assortment</p>	<ul style="list-style-type: none"> ▪ Silicone Nose Pad Assortment 	<p>F 5</p>







Silicone Nose Pads

Symmetrical Nose Pads, "Push-in" System

 10.0 mm	f&w	120 0334 0227 10	20 pieces
		108 3539 0227 10-100	100 pieces
		120 0336 0227 10-200	200 pieces
 13.0 mm	f&w	108 4089 0227 13	20 pieces
		120 0341 0227 13-100	100 pieces
		120 0342 0227 13-200	200 pieces
 14.5 mm	f&w	120 0345 0227 15	20 pieces
		120 0346 0227 15-100	100 pieces
		120 0347 0227 15-200	200 pieces
 16.0 mm	f&w	120 0350 0227 16	20 pieces
		120 0351 0227 16-100	100 pieces
		120 0352 0227 16-200	200 pieces
 18.0 mm	f&w	120 0355 0227 18	20 pieces
		120 0356 0227 18-100	100 pieces
		120 0357 0227 18-200	200 pieces

Symmetrical Nose Pads, "Screw-in" System

 10.0 mm	f&w	120 0361 0228 10	20 pieces
		108 3540 0228 10-100	100 pieces
		120 0363 0228 10-200	200 pieces
 13.0 mm	f&w	108 4088 0228 13	20 pieces
		120 0367 0228 13-100	100 pieces
		120 0369 0228 13-200	200 pieces
 14.5 mm	f&w	120 0372 0228 15	20 pieces
		120 0373 0228 15-100	100 pieces
		120 0374 0228 15-200	200 pieces
 16.0 mm	f&w	120 0377 0228 16	20 pieces
		120 0378 0228 16-100	100 pieces
		120 0379 0228 16-200	200 pieces
 18.0 mm	f&w	120 0382 0228 18	20 pieces
		120 0383 0228 18-100	100 pieces
		120 0384 0228 18-200	200 pieces

Ultra Slim, Symmetrical Nose Pads, "Push-in" System

 13.0 mm		120 0287 0219 13	20 pieces
		120 0289 0219 13-50	50 pieces
		120 0288 0219 13-100	100 pieces
 15.0 mm		120 0292 0219 15	20 pieces
		120 0294 0219 15-50	50 pieces
		120 0293 0219 15-100	100 pieces

Ultra Slim, Symmetrical Nose Pads, "Screw-in" System

 13.0 mm		120 0387 0229 13	20 pieces
		120 0389 0229 13-50	50 pieces
		120 0388 0229 13-100	100 pieces
 15.0 mm		120 0392 0229 15	20 pieces
		120 0394 0229 15-50	50 pieces
		120 0393 0229 15-100	100 pieces

Silicone Nose Pads



Round and Classic, "Push-in" System



9.0 mm

f&w

108 0758

0278 09

20 pieces

120 0488

0278 09-100

100 pieces



15.0 mm

f&w

108 2570

0216 15

10 pairs

120 0266

0216 15-50

50 pairs

120 0265

0216 15-100

100 pairs



17.0 mm

f&w

120 0269

0216 17

10 pairs

120 0271

0216 17-50

50 pairs

120 0270

0216 17-100

100 pairs



19.0 mm

f&w

120 0274

0216 19

10 pairs

120 0276

0216 19-50

50 pairs

120 0275

0216 19-100

100 pairs



Round and Classic, "Screw-in" System



9.0 mm

f&w

108 0759

0288 09

20 pieces

120 0516

0288 09-100

100 pieces



15.0 mm

f&w

108 2571

0226 15

10 pairs

120 0319

0226 15-50

50 pairs

120 0318

0226 15-100

100 pairs



17.0 mm

f&w

120 0322

0226 17

10 pairs

120 0326

0226 17-50

50 pairs

120 0323

0226 17-100

100 pairs



19.0 mm

f&w

120 0329

0226 19

10 pairs

120 0331

0226 19-50

50 pairs

120 0330

0226 19-100

100 pairs

Silicone Nose Pad Assortment

In organiser boxes No. 120 1817.

Contents: 12 of the most used silicone nose pads and nose bridges, altogether 172 pieces

We reserve the right to change the assortment.

120 0230
0200 10

 210 g



Our small parts organiser boxes can be found on page G 12 and G 13.



Comfort Nose Pads



Air Active Pads

consist of extremely flexible silicone material which offers the wearer extra comfort due to the air cushions and helps to avoid pressure marks.

frey & winkler
CREATIVE SILICONE PRECISION



Air Active Pads, Symmetrical, "Push-in" System			
 13.0 mm	f&w	120 0521 0296 13	10 pieces
 14.5 mm	f&w	120 0522 0296 14	10 pieces
 14.5 mm	f&w	130 1450	10 pieces
 17.0 mm	f&w	120 0523 0296 17	10 pieces

Air Active Pads, Symmetrical, "Screw-in" System			
 11.0 mm	f&w	120 0524 0297 11	10 pieces
 14.5 mm	f&w	120 0525 0297 14	10 pieces
 17.0 mm	f&w	120 0526 0297 17	10 pieces
 14.5 mm	f&w	120 0527 0297 25	10 pieces

"System 3 AirTec"			
 11.0 mm	f&w	120 0528 0298 11	10 pieces

"System 3 AirTec"			
 11.9 mm	f&w	108 4095 0298 12	10 pieces

Silicone Nose Pads and TPE

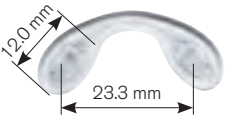
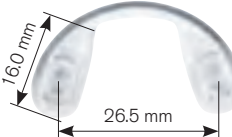
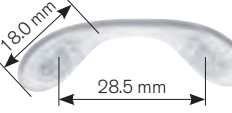

Saddle Bridges Silicone, "Push-in" System

	f&w 120 0306 0225 12	3 pieces
	120 0307 0225 12-9	9 pieces
	f&w 120 0309 0225 16	3 pieces
	120 0310 0225 16-9	9 pieces
	f&w 120 0312 0225 18	3 pieces
	120 0313 0225 18-9	9 pieces

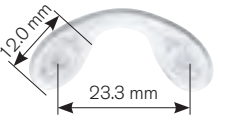
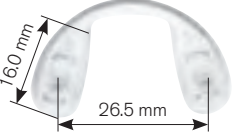
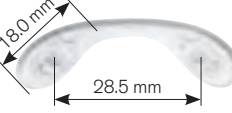
Saddle Bridges Silicone, "Screw-in" System

	f&w 120 0401 0235 12	3 pieces
	120 0402 0235 12-9	9 pieces
	f&w 120 0404 0235 16	3 pieces
	120 0405 0235 16-9	9 pieces
	f&w 120 0407 0235 18	3 pieces
	120 0408 0235 18-9	9 pieces

"System 3" Silicone

	f&w 109 2179 0279 11	20 pieces
	f&w 109 2180 0279 13	20 pieces
	f&w 109 2181 0279 51	10 pairs
	cuneiform	

"System 3 Dash M" Silicone

	f&w 120 0485 0276 11	20 pieces
---	---	-----------

With modified, movable base for better comfort.

"System 3" TPE (Thermoplastic elastomer)

	f&w 109 2182 0274 11	20 pieces
---	---	-----------





The suitable pad arm No. 109 2673 is shown on page F 21.



Silicone Nose Pads and PVC Nose Pads, Medium Soft







Primadonna System Silicone

	f&w	120 0508 0280 09	20 pieces
9.0 mm			
	f&w	120 0251 0212 13	20 pieces
13.0 mm		120 0252 0212 13-100	100 pieces
	f&w	120 0254 0212 15	10 pairs
14.5 mm			



Primadonna System PVC

	f&w	120 0256 0213 13	20 pieces
13.0 mm		120 0257 0213 13-100	100 pieces









Air Titanium and Minimal Art Silicone

	f&w	120 0491 0279 08	20 pieces
8.0 mm		120 0492 0279 08-100	100 pieces
	f&w	120 0495 0279 09	20 pieces
9.0 mm		120 0496 0279 09-100	100 pieces
	f&w	120 0499 0279 10	20 pieces
9.5 mm		120 0500 0279 10-100	100 pieces
		Greater stability due to inserted plastic pin.	
	f&w	120 0504 0279 12	20 pieces
12.0 mm			
	f&w	120 0506 0279 15	20 pieces
15.5 mm			
		120 0448 0270 11	10 pairs
11.0 mm			





Air Titanium and Minimal Art PVC

	f&w	120 0449 0271 09	20 pieces
9.5 mm			
	f&w	120 0450 0271 11	20 pieces
11.5 mm			

PVC Nose Pads, Medium Soft, with Plastic Insert

Transparent, "Push-in" System				Transparent, "Screw-in" System			
	f&w	120 0451 0272 09	20 pieces		f&w	120 0467 0273 09	20 pieces
		120 0452 0272 09-100	100 pieces			120 0468 0273 09-100	100 pieces
	f&w	120 0455 0272 13	20 pieces		f&w	120 0471 0273 13	20 pieces
		108 3543 0272 13-100	100 pieces			108 3544 0273 13-100	100 pieces
	f&w	120 0459 0272 15	10 pairs		f&w	120 0475 0273 15	10 pairs
		120 0460 0272 15-50	50 pairs			120 0476 0273 15-50	50 pairs
	f&w	120 0463 0272 17	10 pairs		f&w	120 0479 0273 17	10 pairs
		120 0464 0272 17-50	50 pairs			120 0480 0273 17-50	50 pairs

PVC Nose Pads, Medium Soft, with Metal Insert

Transparent, Silver, "Push-in" System				Transparent, Gold, "Screw-in" System			
					120 0435 0256 15		20 pieces
		108 4087 0230 15	20 pieces		108 0755 0255 12		20 pieces
					108 0757 0255 15		20 pieces
					120 0434 0255 17		20 pieces



TIPS & TRICKS

SILICONE NOSE PADS MINIFITS

Non Slipping Plastic Frames

Silicone Pads Minifits

No. 120 0400

Ruler

No. 120 2795

Universal Pen

No. 120 3040

Tool Holder

No. 120 2592

Spiral Drill, HSS

No. 120 2526



approx. 15 minutes

This is how it works

1 MARK POSITION



2 DRILL 1ST HOLE

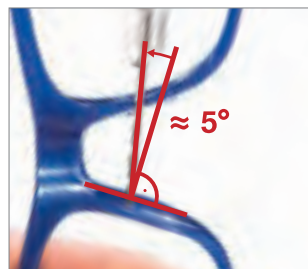

3 DRILL 2ND HOLE

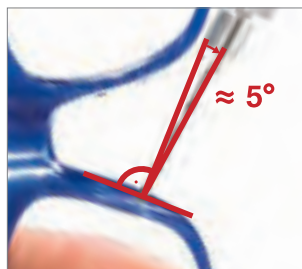











4 MOUNT THE MINIFITS



5 DONE









Polycarbonate Pads, Hard

	Ultra slim, especially transparent and light, "Push-in" System	 12.0 mm		120 0427 0253 22	20 pieces
	Ultra slim, especially transparent and light, "Screw-in" System	 12.0 mm		120 0431 0254 22	20 pieces
	Especially transparent and light, "Push-in" System	 13.0 mm	f&w	120 0424 0253 12	20 pieces
	Especially transparent and light, "Screw-in" System	 13.0 mm	f&w	120 0428 0254 12	20 pieces

Special Nose Pads and Nose Bridges

Nose Pads for Special Applications



 7.0 mm		120 0231 0201 07	20 pieces
 14.0 mm	f&w	120 0447 0267 14	10 pieces
 14.0 mm	f&w	120 0400 0232 01	10 pieces
 19.0 mm		120 0486 0277 01	3 pairs

Nose Pads for ic! berlin Frames

 14.0 mm	ic! berlin	120 0444 0264 01	4 pieces
 14.0 mm	ic! berlin	120 0445 0264 02	4 pieces
 14.0 mm	ic! berlin	120 0446 0264 03	4 pieces



Special Nose Pads and Nose Bridges

 Logic® , Symmetrical, “Screw-in” and “Push-in” System	
 13.0 mm	Logic® 120 0280 0217 13 20 pieces
	120 0281 0217 13-100 100 pieces
 15.0 mm	Logic® 120 0283 0217 15 20 pieces
	120 0284 0217 15-100 100 pieces



Silicone Nose Bridges, small



 14.9 mm	f&w 120 0413 0241 01 3 pieces Gold, for metal frames
	f&w 120 0414 0241 10 3 pieces Silver, for metal frames

Silicone Nose Bridges, large





















 16.9 mm	f&w 120 0415 0242 01 3 pieces Gold, for metal frames
	f&w 120 0416 0242 10 3 pieces Silver, for metal frames

Hypo-allergenic Special Nose Pads

 PCTG , hypo-allergenic, “Push-in” System	
 13.0 mm	121 1511 0294 13 10 pieces PCTG – Polyethylenterephthalat Glycol
	121 1512 0294 15 10 pieces PCTG – Polyethylenterephthalat Glycol

 PCTG , hypo-allergenic, “Screw-in” System	
 13.0 mm	121 1513 0295 13 10 pieces PCTG – Polyethylenterephthalat Glycol
	121 1514 0295 15 10 pieces PCTG – Polyethylenterephthalat Glycol

Hypo-allergenic Special Nose Pads

Titanium, hypo-allergenic, "Push-in" System		Titanium, hypo-allergenic, "Screw-in" System			
 8.0 mm	f&w 120 0436 0257 08	4 pieces	 8.0 mm	f&w 120 0439 0258 08	4 pieces
	120 0437 0257 08-10	10 pieces		120 0440 0258 08-10	10 pieces
	Gun polished			Gun polished	
 13.0 mm	f&w 120 0232 0203 01	4 pieces	 13.0 mm	f&w 120 0240 0204 01	4 pieces
	Gun polished			Gun polished	
 13.0 mm	f&w 120 0233 0203 02	4 pieces	 13.0 mm	f&w 120 0241 0204 02	4 pieces
	Gun matte			Gun matte	
 13.0 mm	120 0234 0203 11	4 pieces	 13.0 mm	120 0242 0204 11	4 pieces
	Gold polished			Gold polished	
 13.0 mm	120 0235 0203 12	4 pieces	 13.0 mm	120 0243 0204 12	4 pieces
	Gold matte			Gold matte	
 13.0 mm	120 0236 0203 21	4 pieces	 13.0 mm	120 0244 0204 21	4 pieces
	Rose gold polished			Rose gold polished	
 13.0 mm	120 0237 0203 22	4 pieces	 13.0 mm	120 0245 0204 22	4 pieces
	Rose gold matte			Rose gold matte	
 13.0 mm	120 0238 0203 31	4 pieces	 13.0 mm	120 0246 0204 31	4 pieces
	Black polished			Black polished	
 13.0 mm	120 0239 0203 32	4 pieces	 13.0 mm	120 0247 0204 32	4 pieces
	Black matte			Black matte	



Special Nose Pads



Silicone with Titanium Screw Holder,
hypo-allergenic, "Screw-in" System



120 0442
0259 01

4 pieces

13.0 mm



Nose Pads for Ray Ban Frames



120 0417
0243 02

10 pieces

Soft-PVC

With adjustable flaps

15.0 mm



120 0418
0243 03

10 pieces

Soft-PVC

With adjustable flaps

15.0 mm



Silicone



109 6012
0243 12

10 pieces

Silicone

With adjustable flaps

15.0 mm



Silicone



120 0420
0243 13

10 pieces

Silicone

With adjustable flaps

15.0 mm



Nose Pad Cushions



PAINEX Assortment of Sponge Cushions

To reduce the bridge width.

Self-adhesive, white.

1 strip = 4 pairs

Contents: 12 strips of 1.0 mm thickness
12 strips of 1.5 mm thickness
12 strips of 2.0 mm thickness

120 1000
0739 00

Improves the comfort of
wearing plastic frames

PAINEX Sponge Cushions

Single thickness.

1 strip = 4 pairs

Contents: 12 strips

120 1001 $\frac{+}{-}$ 1.0 mm
0739 10

120 1002 $\frac{+}{-}$ 1.5 mm
0739 15

120 1003 $\frac{+}{-}$ 2.0 mm
0739 20



0.8 > 2.0 mm

Nose Pad Components

Asymmetric nose pad component adhering to plastic frames.

Can be used with e.g. Acetone No. 120 3923.

Contents: 6 pairs

120 0443 $\frac{+}{-}$ 19 x 8 mm $\frac{+}{-}$ 0.8 > 2.0 mm
0263 00



TIPS & TRICKS
SELF-ADHESIVE NOSE PAD CUSHION
One Cushion, 2 Options
Nose Pad Cushion Assortment

No. 109 4751

or separately:

Self-adhesive Nose Pad Cushion

No. 109 4752, -53, -54

This is how it works
Option 1: Cut off
1 CLEAN THE FRAME

2 REMOVE HALF OF THE FOIL

3 STICK ON

4 CUT OFF

5 DONE

Option 2: Fold back | Repeat step 1–3
4 REMOVE THE FOIL

5 FOLD BACK THE FLAP

6 DONE

Nose Pad Cushion

Self-adhesive **silicone foil**.

Width: 7 mm each

Contents: 10 pairs

109 4752 0758 01	Size S		19 mm		2.0 mm
109 4753 0758 02	Size M		19 mm		2.4 mm
109 4754 0758 03	Size L		19 mm		2.7 mm



Nose Pad Cushion Assortment

Contents: 10 pairs each No. 109 4752; 109 4753 and 109 4754

109 4751 30 pairs
0758 50



Due to deposits (cosmetics/skin oil) we recommend replacing after approx. 3 to 4 weeks.



Nose Pad Cushion

Self-adhesive **silicone foil**.

Contents: 20 pieces



120 1052 0748 13		13 mm		0.7 mm
120 1053 0748 15		15 mm		0.7 mm
120 1054 0748 17		17 mm		0.7 mm
120 1055 0748 19		19 mm		0.7 mm
120 1056 0748 23		13 mm		1.0 mm
120 1057 0748 25		15 mm		1.0 mm
120 1058 0748 27		17 mm		1.0 mm
120 1059 0748 29		19 mm		1.0 mm



Almost invisible

Nose Pad Cushion Assortment

Contents: 20 pieces each No. 120 1052; 120 1053; 120 1054 and 120 1055

120 1061 80 pieces
0748 50

Nose Pad Cushion Assortment

Contents: 20 pieces each No. 120 1056; 120 1057; 120 1058 and 120 1059

120 1062 80 pieces
0748 51



TIPS & TRICKS
NOSE PAD ARMS FOR PLASTIC FRAMES

Improve Comfort!

Mounting Set

No. 120 0550

or separately:

Nose Pad Arms, Beta-titanium

used for example: No. 120 0540

Mounting Tool

No. 120 0539

Spiral Drill, HSS

No. 120 2525

Plastic Pad

No. 120 0424

Pad Screws

No. 120 1469

Tool Holder

No. 120 2595

Steel Miller

No. 120 2732

Universal Pen

No. 120 3040



15 minutes

This is how it works

1 CUTTING

2 POLISHING

3 MARKING

4 DRILLING

5 CLAMPING

6 PUSHING

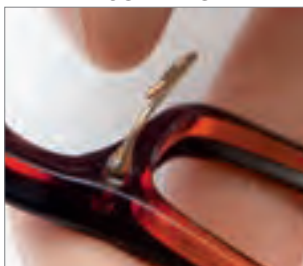
7 INSERTING THE NOSE PADS

8 DONE

Plastic frames for everyone

The high-quality side bar supports, made in Japan of beta titanium, improve the wearing comfort of a plastic frame that does not fit perfectly, it can be anatomically adapted at any time. Due to their graceful shape, as well as the various colour and size options, they are inconspicuous and enhance any plastic frame.



Beta Titanium

- Attaches through one point system
- One drill hole required
- Simply pushes in
- Matching drill: No. 120 2525



"Push-in" System

120 0540-49

2 pairs

Size S 10 mm		Size L 12 mm		Size XL 16 mm	
Order No.	Colour	Order No.	Colour	Order No.	Colour
120 0547 0304 21	Silver	120 0540 0304 01	Silver	120 0544 0304 11	Silver
120 0548 0304 25	Black	120 0541 0304 03	Brown	120 0545 0304 15	Black
120 0549 0304 26	Gold	120 0542 0304 05	Black	120 0546 0304 16	Gold
		120 0543 0304 06	Gold		

"Screw-in" System

120 0552-61

2 pairs

Size S 10 mm		Size L 12 mm		Size XL 16 mm	
Order No.	Colour	Order No.	Colour	Order No.	Colour
120 0559 0305 21	Silver	120 0552 0305 01	Silver	120 0556 0305 11	Silver
120 0560 0305 25	Black	120 0553 0305 03	Brown	120 0557 0305 15	Black
120 0561 0305 26	Gold	120 0554 0305 05	Black	120 0558 0305 16	Gold
		120 0555 0305 06	Gold		

Marking tool "APP"

The Accurate Point Positioner was developed to ensure precise and accurate drill point positioning for the plastic and beta titanium pad arms.

With the new version of the APP you can now perfectly adjust the drilling points in horizontal and vertical direction.

120 0534
0303 10



Mounting Tool for Beta Titanium Nose Pad Arms

- For easy fitting of titanium nose pad arms
- Comfortable handling
- Enables work with pinpoint accuracy

120 0539
0304 00



Mounting Set Nose Pad Arms Beta Titanium

- **Contents:** Tool for nose pad arms, 16 pairs nose pad arms, required drill (No. 120 2525), matching nose pads (No. 120 0334 and 120 0361) and nose pad screws (No. 120 1469)
- In practical box

120 0550
0304 50

105 x 23.5 x 178 mm



The matching screws No. 120 1469, 120 1471 and 120 1474 (total length 4.0 mm; thread size 1.0 mm) are shown on page F 24.



Nose Pad Arms for Plastic Frames

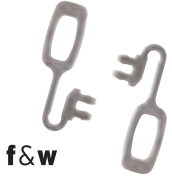

f&w

Type/Use:
"System 3" and "System 3 Dash M"
Colour: Silver

120 0564
0307 01

 5 pairs

Nose Pad Arm Bridges for Plastic Frames



- "Push-in" System
- Mounting through two parallel drilled holes with 1.0 mm diameter
- Distance between drilled holes: 12 mm
- Fixation through 2 pin connection
- Colour: Silver

120 0563
0306 02

 2 pieces



- "Screw-in" System
- Mounting through two parallel drilled holes with 1.0 mm diameter
- Distance between drilled holes: 12 mm
- Fixation through 2 pin connection
- Colour: Silver

120 0562
0306 01

 2 pieces



Nose Pad Arms for Metal Frames



Type/Use:
Universal application
Colour: Silver

120 0512
0288 01  10 pieces



Type/Use:
Universal application
Colour: Gold

120 0513
0288 02  10 pieces



Type/Use:
Universal application
Colour: Silver

120 0519
0289 01  10 pieces



Type/Use:
Universal application
Colour: Silver

120 0509
0287 01  5 pairs



Type/Use:
Universal application
Colour: Gold

120 0510
0287 02  5 pairs



Type/Use:
Universal application
Colour/Material: Titanium

120 0511
0287 03  5 pairs



Type/Use:
"System 3" and "System 3 Dash M"
Colour: Silver

109 2673
0276 01  10 pieces



The suitable nose pads "System 3" and "System 3 Dash M" are shown on page F 7.



The B&S Screw Range:

- Extensive selection
- For all applications
- Easy to find. Simple to order



Ordering in 3 Steps

OPTION

A

Ascending
thread size

F 24–F 34

1. Select the thread size (Option A)
2. Select the screws type
3. Select the colour

OPTION

B

Screws for
special applications

F 35–F 46

1. Select your special screw (Option B)
2. Select the size
3. Select the colour

Icons makes your selection easy

Screws for:



Nose pads



Rim joints



Hinges



Rimless frames

Shapes:



Slotted screw



Phillips screw



Phillips/slotted
combination



Star nut



Hexagon screw/nut



Torx screw

Measurements:



Screw securer



Thread size



Head diameter



Total length



Diameter



Inner diameter



Outer diameter

OPTION A

Thread Size – assorted

0.8–1.0 mm	F 24
1.1 mm	F 25
1.2 mm	F 25–F 26
1.3 mm	F 27
1.4 mm	F 28–F 31
1.5 mm	F 32–F 33
1.6 mm	F 33–F 34
1.7–1.8 mm	F 34

OPTION B

Special Screws

4-in-1 Screws	F 35–F 37
Rimless Frames Screws	F 38
Screws for Ray Ban Frames	F 39
Torx Screws	F 40
Screws for Plastic Hinges	F 41
Spring Hinge Screws	F 41–F 42
Spring Hinge Screws with blue Screw Securer	F 43
Hilco Logic® Screws	F 44
Screws with transparent Nylon Securer	F 45
Temple Screws	F 45
Screws with black Screw Securer	F 46
Screws with blue Tuflock Securer	F 46

And much more









Assortments	F 47–F 48
Nuts	F 49–F 50
Washers	F 50–F 51
Sleeves	F 52–F 53



Screws ascending Thread Size







































































Thread Size 0.8 mm

		Function	Screw head	Material	Colour			Order No.		Matching nut
				German Silver	Silver	3.70	1.30	120 1177 0805 10	100 pieces	–



Thread Size 1.0 mm

		Function	Screw head	Material	Colour			Order No.		Matching nut
				Steel	Silver	3.80	1.80	120 1389 0865 01	100 pieces	–
				Steel	Gold	3.80	1.80	120 1390 0865 10	100 pieces	–
				German Silver	Silver	4.00	1.20	120 1189 0815 00	100 pieces	–
				German Silver	Silver	4.00	1.40	120 1469 0896 00	100 pieces	–
				German Silver	Gold	4.00	1.40	120 1473 0896 10	100 pieces	–
				German Silver	Gun	4.00	1.40	120 1474 0896 20	100 pieces	–
				German Silver	Silver	4.00	1.40	120 1471 0896 00TL	50 pieces	–
				Steel	Silver	4.45	1.40	120 1178 0807 00	100 pieces	–
				Steel	Silver	4.50	1.80	120 1459 0889 00	100 pieces	–
				Steel	Silver	5.80/ 2.80	1.40	120 1247 0819 05	100 pieces	–
				Steel	Silver	5.80/ 2.80	1.40	120 1248 0819 05TL	50 pieces	–
				Steel	Gold	5.80/ 2.80	1.40	120 1264 0819 15	100 pieces	–
				Steel	Gold	5.80/ 2.80	1.40	120 1265 0819 15TL	50 pieces	–
				Steel	Silver	12.80/ 2.80	1.40	120 1190 0816 000	50 pieces	–
				Steel	Gold	12.80/ 2.80	1.40	120 1206 0816 100	50 pieces	–
				Steel	Gun	12.80/ 2.80	1.40	120 1218 0816 200	50 pieces	–



Screw securer

Screws ascending Thread Size



Thread Size 1.1 mm

		Function	Screw head	Material	Colour			Order No.		Matching nut
				German Silver	Silver	4.20	1.30	120 1173 0803 00	100 pieces	-



Thread Size 1.2 mm

		Function	Screw head	Material	Colour			Order No.		Matching nut
				Steel	Silver	1.30	1.80	120 1172 0801 00	100 pieces	-
				Steel	Silver	2.60	1.60	120 1377 0860 40	100 pieces	-
				Steel	Silver	3.00	2.00	120 1432 0886 03	100 pieces	-
				Steel	Gun for plastic hinges	3.00	2.30	120 1301 0833 20	50 pieces	-
				Steel	Silver	3.20	1.60	120 1353 0853 00	100 pieces	-
				Steel	Silver	3.40	1.60	120 1419 0882 00	100 pieces	-
				Steel	Gold	3.40	1.60	120 1420 0882 10	100 pieces	-
				Steel	Silver	3.50	2.00	120 1433 0886 04	100 pieces	-
				Steel	Silver	3.90	2.00	109 2223 0886 00	100 pieces	-
				Steel	Silver	4.00	1.40	120 1472 0896 01	100 pieces	-
				Steel	Silver	4.00	2.00	120 1434 0886 05	100 pieces	-
				Steel	Silver	4.40	2.00	109 2224 0886 01	100 pieces	-
				Steel	Silver	4.70	1.60	120 1405 0871 00	100 pieces	-
				German Silver	Silver	4.80	1.60	120 1235 0818 00	100 pieces	-
				Steel	Silver	4.90	2.00	109 2225 0886 02	100 pieces	-
				Steel	Silver	5.90/ 3.50	2.00	120 1243 0819 03	100 pieces	-
				Steel	Silver	5.90/ 3.50	2.00	120 1244 0819 03TL	50 pieces	-
				Steel	Gold	5.90/ 3.50	2.00	120 1260 0819 13	100 pieces	-
				Steel	Gold	5.90/ 3.50	2.00	120 1261 0819 13TL	50 pieces	-

Screw securer



Screws ascending Thread Size



Thread Size 1.2 mm









































































		Function	Screw head	Material	Colour			Order No.		Matching nut
				Steel	Gun	5.90/ 3.50	2.00	120 1272 0819 23	100 pieces	–
				Steel	Gun	5.90/ 3.50	2.00	120 1273 0819 23TL	50 pieces	–
				Steel	Silver	7.00	2.00	120 1421 0883 00	100 pieces	–
				Steel	Silver	7.00/ 4.00	2.00	120 1253 0819 08	100 pieces	–
				Steel	Silver	7.50/ 4.50	2.00	120 1254 0819 09	100 pieces	–
				Steel	Silver	10.00	2.40	120 1425 0885 00	100 pieces	–
				Steel	Silver	11.60	2.00	109 4234 0888 00	25 pieces	–
				Steel	Gold	11.60	2.00	109 4240 0888 10	25 pieces	–
				Steel	Black	11.60	2.00	109 4246 0888 20	25 pieces	–
				German Silver	Silver	12.00	1.80	120 1295 0831 00	100 pieces	120 1277 0822 01TL
				Brass	Gold	12.00	1.80	120 1296 0831 10	100 pieces	120 1279 0822 02TL
				Brass	Gun	12.00	1.80	120 1297 0831 20	100 pieces	120 1280 0822 03
				German Silver	Silver	12.00	2.50	120 1319 0841 01	100 pieces	120 1277 0822 01TL
				German Silver	Gold	12.00	2.50	120 1321 0841 11	100 pieces	120 1279 0822 02TL
				Steel	Silver	12.60	2.20	120 1367 0858 00	100 pieces	120 1277 0822 01TL
				Steel	Gold	12.60	2.20	120 1369 0858 10	100 pieces	120 1279 0822 02TL
				Steel	Silver	14.80/ 4.80	1.80	120 1191 0816 001	50 pieces	–
				Steel	Gold	14.80/ 4.80	1.80	120 1207 0816 101	50 pieces	–
				Steel	Gun	14.80/ 4.80	1.80	120 1219 0816 201	50 pieces	–
				German Silver	Silver	15.00	1.80	120 1333 0843 00	100 pieces	120 1277 0822 01TL
				Steel	Silver	15.50/ 5.50	1.80	120 1202 0816 012	50 pieces	–



Screws ascending Thread Size



Thread Size 1.3 mm

		Function	Screw head	Material	Colour			Order No.		Matching nut
				Steel	Silver	3.50	1.70	120 1416 0880 00	100 pieces	-
				Steel	Gold	3.50	1.70	120 1417 0880 10	100 pieces	-
				German Silver	Silver	5.30	1.70	120 1175 0804 00	100 pieces	-
				German Silver	Gun	5.30	1.70	120 1176 0804 20	100 pieces	-
				Steel	Silver	6.50/ 3.50	2.00	120 1249 0819 06	100 pieces	-
				Steel	Silver	6.50/ 3.50	2.00	120 1250 0819 06TL	50 pieces	-
				Steel	Gold	6.50/ 3.50	2.00	120 1266 0819 16	100 pieces	-
				Steel	Gold	6.50/ 3.50	2.00	120 1267 0819 16TL	50 pieces	-
				Steel	Silver	7.00	1.80	120 1382 0861 00	100 pieces	-
				German Silver	Silver	8.00	2.80	120 1341 0848 00	100 pieces	-
				Steel	Silver	11.50	1.80	120 1383 0861 01	50 pieces	-
				Steel	Gold	11.50	1.80	120 1384 0861 11	50 pieces	-
				Steel	Silver	11.60	2.00	109 4235 0888 01	25 pieces	-
				Steel	Gold	11.60	2.00	109 4241 0888 11	25 pieces	-
				Steel	Black	11.60	2.00	109 4247 0888 21	25 pieces	-
				Steel	Silver	14.80/ 4.80	1.80	120 1192 0816 002	50 pieces	-
				Steel	Gold	14.80/ 4.80	1.80	120 1208 0816 102	50 pieces	-
				Steel	Gun	14.80/ 4.80	1.80	120 1220 0816 202	50 pieces	-



Screws ascending Thread Size



Thread Size 1.4 mm





































































































		Function	Screw head	Material	Colour			Order No.		Matching nut
				Steel	Silver	2.80	1.80	120 1347 0851 01	100 pieces	-
				Steel	Silver	3.00	2.00	120 1180 0811 00	50 pieces	-
			 TX4	Steel	Silver	3.00	2.00	120 1438 0887 03	100 pieces	-
				Steel	Silver	3.10	2.00	120 1410 0874 00	100 pieces	-
				Steel	Silver	3.30	2.00	120 1401 0869 01	100 pieces	-
				Steel	Silver	3.40	1.80	120 1348 0851 02	100 pieces	-
				Steel	Silver	3.45	2.00	120 1356 0854 00	100 pieces	-
				Steel	Silver	3.50	2.00	120 1181 0811 01	50 pieces	-
			 TX4	Steel	Silver	3.50	2.00	120 1439 0887 04	100 pieces	-
				Steel	Silver	3.60	2.00	120 1422 0884 00	100 pieces	-
				Steel	Silver	3.70	2.00	120 1402 0869 02	100 pieces	-
				Steel	Silver	3.90	2.00	120 1400 0869 00	100 pieces	-
				Steel	Silver	3.90	1.80	120 1406 0872 00	100 pieces	-
				Steel	Gold	3.90	1.80	120 1407 0872 10	100 pieces	-
				Steel	Gun	3.90	1.80	120 1408 0872 20	100 pieces	-
			 TX4	Steel	Silver	3.90	2.00	109 2226 0887 00	100 pieces	-
				Steel	Silver	4.00	1.80	120 1349 0851 03	100 pieces	-
				Steel	Silver	4.00	2.00	120 1411 0876 00	100 pieces	-
				Steel	Silver	4.00	2.00	120 1182 0811 02	50 pieces	-
			 TX4	Steel	Silver	4.00	2.00	120 1440 0887 05	100 pieces	-
				Steel	Silver	4.10	1.80	120 1378 0860 55	100 pieces	-
				German Silver	Silver	4.20	1.80	120 1188 0814 00	200 pieces	-
				Steel	Silver	4.20	1.80	120 1412 0876 01	100 pieces	-
				Steel	Silver	4.20	2.00	120 1403 0869 03	100 pieces	-



Screws ascending Thread Size



Thread Size 1.4 mm

		Function	Screw head	Material	Colour			Order No.		Matching nut
				Steel	Silver	4.30	1.80	120 1346 0851 00	100 pieces	-
				Steel	Silver	4.30	2.00	120 1394 0867 00	100 pieces	-
				Steel	Gold	4.30	2.00	120 1399 0868 00	100 pieces	-
				Steel	Silver	4.40	1.80	120 1409 0873 00	100 pieces	-
				Steel	Silver	4.40	2.00	120 1423 0884 01	100 pieces	-
			 TX4	Steel	Silver	4.40	2.00	109 2227 0887 01	100 pieces	-
				Steel	Silver	4.50	2.00	120 1183 0811 03	50 pieces	-
				Steel	Silver	4.70	2.00	120 1424 0884 02	100 pieces	-
				German Silver	Silver	4.80	2.50	120 1275 0821 00	100 pieces	-
			 TX4	Steel	Silver	4.90	2.00	109 2228 0887 02	100 pieces	-
				German Silver	Silver	5.00	1.80	120 1274 0820 00	200 pieces	-
				Steel	Silver	5.20	1.80	120 1373 0860 20	100 pieces	-
				German Silver	Silver	5.40	1.80	120 1350 0852 00	100 pieces	-
				Steel	Silver	6.00	1.80	120 1379 0860 58	100 pieces	-
				Steel	Silver	6.00	1.80	120 1381 0860 58TL	50 pieces	-
				Steel	Silver	6.50	1.80	120 1374 0860 30	100 pieces	-
				Steel	Silver	6.50	1.80	120 1376 0860 30TL	50 pieces	-
				Steel	Silver	6.50	2.00	120 1187 0813 00	100 pieces	-
				Steel	Silver	6.50/ 3.50	2.00	120 1236 0819 00	100 pieces	-
				Steel	Silver	6.50/ 3.50	2.00	120 1237 0819 00TL	50 pieces	-
				Steel	Silver	7.00/ 4.00	2.00	120 1238 0819 01	100 pieces	-
				Steel	Silver	7.00/ 4.00	2.00	120 1241 0819 01TL	50 pieces	-
				Steel	Silver	7.80/ 4.80	2.00	120 1242 0819 02	100 pieces	-
				Steel	Gold	6.50/ 3.50	2.00	120 1255 0819 10	100 pieces	-



Screws ascending Thread Size



Thread Size 1.4 mm

		Function	Screw head	Material	Colour			Order No.		Matching nut
				Steel	Gold	6.50/ 3.50	2.00	120 1256 0819 10TL	50 pieces	-
				Steel	Gold	7.00/ 4.00	2.00	120 1257 0819 11	100 pieces	-
				Steel	Gold	7.00/ 4.00	2.00	120 1258 0819 11TL	50 pieces	-
				Steel	Gold	7.80/ 4.80	2.00	120 1259 0819 12	100 pieces	-
				Steel	Gun	6.50/ 3.50	2.00	120 1270 0819 20	100 pieces	-
				Steel	Gun	6.50/ 3.50	2.00	120 1271 0819 20TL	50 pieces	-
				Steel for plastic hinges	Silver	7.80	2.00	120 1357 0855 00	50 pieces	-
				German Silver	Silver	8.60	2.80	120 1292 0828 10	100 pieces	-
				Steel	Silver	8.50/ 5.50	2.00	120 1239 0819 010	100 pieces	-
				Steel	Silver	9.50/ 6.50	2.00	120 1240 0819 011	100 pieces	-
				Steel	Silver	10.00	2.80	120 1426 0885 01	100 pieces	-
				Steel	Silver	10.60/ 3.60	1.80	120 1230 0817 00	100 pieces	-
				Steel	Gold	10.60/ 3.60	1.80	120 1233 0817 10	100 pieces	-
				Steel	Gun	10.60/ 3.60	1.80	120 1234 0817 20	100 pieces	-
				Steel for plastic hinges	Silver	10.80	2.00	120 1358 0855 01	50 pieces	-
				German Silver	Silver	11.40	2.80	120 1288 0824 11	100 pieces	120 1284 0824 01TL
				Steel	Silver	11.50	1.80	120 1385 0862 01	50 pieces	-
				Steel	Gold	11.50	1.80	120 1386 0862 11	50 pieces	-
				Steel	Silver	11.60	2.00	109 4236 0888 02	25 pieces	-
				Steel	Gold	11.60	2.00	109 4242 0888 12	25 pieces	-
				Steel	Black	11.60	2.00	109 4248 0888 22	25 pieces	-
				German Silver	Silver	12.00	2.50	120 1318 0841 00	100 pieces	120 1284 0824 01TL
				Brass	Gold	12.00	2.50	120 1320 0841 10	100 pieces	120 1286 0824 02TL
				German Silver	Gun	12.00	2.50	120 1322 0841 20	100 pieces	120 1287 0824 03

Screws ascending Thread Size



Thread Size 1.4 mm

		Function	Screw head	Material	Colour			Order No.		Matching nut
				Steel	Silver	12.60	2.20	120 1368 0858 01	100 pieces	120 1284 0824 01TL
				Steel	Gold	12.60	2.20	120 1370 0858 11	100 pieces	120 1286 0824 02TL
				Steel	Silver	13.00/ 3.00	1.80	120 1193 0816 003	50 pieces	-
				Steel	Gold	13.00/ 3.00	1.80	120 1209 0816 103	50 pieces	-
				Steel	Gun	13.00/ 3.00	1.80	120 1221 0816 203	50 pieces	-
				Steel	Silver	14.80/ 4.80	1.80	120 1194 0816 004	50 pieces	-
				Steel	Gold	14.80/ 4.80	1.80	120 1210 0816 104	50 pieces	-
				Steel	Gun	14.80/ 4.80	1.80	120 1222 0816 204	50 pieces	-
				Steel	Silver	13.50/ 3.50	2.00	120 1197 0816 007	50 pieces	-
				Steel	Gold	13.50/ 3.50	2.00	120 1213 0816 107	50 pieces	-
				Steel	Gun	13.50/ 3.50	2.00	120 1225 0816 207	50 pieces	-
				Steel	Silver	14.00/ 4.00	2.00	120 1198 0816 008	50 pieces	-
				Steel	Gold	14.00/ 4.00	2.00	120 1214 0816 108	50 pieces	-
				Steel	Gun	14.00/ 4.00	2.00	120 1226 0816 208	50 pieces	-
				Steel	Silver	14.80/ 4.80	2.00	120 1199 0816 009	50 pieces	-
				Steel	Gold	14.80/ 4.80	2.00	120 1215 0816 109	50 pieces	-
				Steel	Gun	14.80/ 4.80	2.00	120 1227 0816 209	50 pieces	-
				German Silver	Silver	15.00	1.80	120 1334 0843 01	100 pieces	120 1284 0824 01TL
				Steel	Silver	15.50/ 5.50	2.00	120 1203 0816 013	50 pieces	-



Screws ascending Thread Size



Thread Size 1.5 mm

		Function	Screw head	Material	Colour			Order No.		Matching nut
				German Silver	Silver	5.00	1.80	120 1340 0845 15	100 pieces	-
				Steel for plastic hinges	Silver	5.00	2.00	120 1361 0855 04	50 pieces	-
				Steel	Silver	5.20	1.80	120 1323 0842 00	100 pieces	-
				Steel	Silver	5.20	1.80	120 1325 0842 00TL	50 pieces	-
				Steel	Silver	6.50/ 3.50	2.00	120 1251 0819 07	100 pieces	-
				Steel	Silver	6.50/ 3.50	2.00	120 1252 0819 07TL	50 pieces	-
				Steel	Gold	6.50/ 3.50	2.00	120 1268 0819 17	100 pieces	-
				Steel	Gold	6.50/ 3.50	2.00	120 1269 0819 17TL	50 pieces	-
				German Silver	Silver	10.00	2.80	120 1291 0827 00	100 pieces	-
				Steel	Silver	11.50	1.80	120 1387 0863 01	50 pieces	-
				Steel	Gold	11.50	1.80	120 1388 0863 11	50 pieces	-
				Steel	Silver	11.60	2.00	109 4237 0888 03	25 pieces	-
				Steel	Gold	11.60	2.00	109 4243 0888 13	25 pieces	-
				Steel	Black	11.60	2.00	109 4249 0888 23	25 pieces	-
				Steel	Silver	14.00/ 4.00	1.80	120 1195 0816 005	50 pieces	-
				Steel	Gold	14.00/ 4.00	1.80	120 1211 0816 105	50 pieces	-
				Steel	Gun	14.00/ 4.00	1.80	120 1223 0816 205	50 pieces	-
				Steel	Silver	14.80/ 4.80	1.80	120 1196 0816 006	50 pieces	-
				Steel	Gold	14.80/ 4.80	1.80	120 1212 0816 106	50 pieces	-
				Steel	Gun	14.80/ 4.80	1.80	120 1224 0816 206	50 pieces	-
				Steel	Silver	14.00/ 4.00	2.00	120 1200 0816 010	50 pieces	-
				Steel	Gold	14.00/ 4.00	2.00	120 1216 0816 110	50 pieces	-
				Steel	Gun	14.00/ 4.00	2.00	120 1228 0816 210	50 pieces	-
				Steel	Silver	14.80/ 4.80	2.00	120 1201 0816 011	50 pieces	-



Screw securer

Screws ascending Thread Size



Thread Size 1.5 mm

		Function	Screw head	Material	Colour			Order No.		Matching nut
				Steel	Gold	14.80/ 4.80	2.00	120 1217 0816 111	50 pieces	-
				Steel	Gun	14.80/ 4.80	2.00	120 1229 0816 211	50 pieces	-



Thread Size 1.6 mm

















		Function	Screw head	Material	Colour			Order No.		Matching nut
				Steel	Silver	3.50	2.50	120 1184 0811 04	50 pieces	-
				Steel for plastic hinges	Silver	4.00	2.50	120 1363 0855 06	50 pieces	-
				Steel	Silver	4.00	2.50	120 1185 0811 05	50 pieces	-
				Steel	Silver	4.60	2.50	120 1186 0811 06	50 pieces	-
				Steel	Silver	5.20	1.80	120 1326 0842 01	100 pieces	-
				Steel	Silver	5.20	1.80	120 1328 0842 01TL	50 pieces	-
				Steel	Gold	5.20	1.80	120 1330 0842 11	100 pieces	-
				Steel for plastic hinges	Silver	5.20	2.50	120 1364 0855 07	50 pieces	-
				Steel for plastic hinges	Silver	6.00	2.50	120 1362 0855 05	50 pieces	-
				Steel	Silver	6.50/ 3.50	2.00	120 1245 0819 04	100 pieces	-
				Steel	Silver	6.50/ 3.50	2.00	120 1246 0819 04TL	50 pieces	-
				Steel	Gold	6.50/ 3.50	2.00	120 1262 0819 14	100 pieces	-
				Steel	Gold	6.50/ 3.50	2.00	120 1263 0819 14TL	50 pieces	-
				Steel for plastic hinges	Silver	7.80	2.00	120 1359 0855 02	50 pieces	-
				German Silver	Silver	9.00	2.80	120 1306 0837 10	100 pieces	-
				Steel	Silver	10.00	2.80	120 1428 0885 03	100 pieces	-
				Steel for plastic hinges	Silver	10.80	2.00	120 1360 0855 03	50 pieces	-



Screws ascending Thread Size











Thread Size 1.6 mm

		Function	Screw head	Material	Colour			Order No.		Matching nut
				Steel	Silver	11.60	2.00	109 4238 0888 04	25 pieces	-
				Steel	Gold	11.60	2.00	109 4244 0888 14	25 pieces	-
				Steel	Black	11.60	2.00	109 4250 0888 24	25 pieces	-



















Thread Size 1.7 mm

		Function	Screw head	Material	Colour			Order No.		Matching nut
				German Silver	Silver	7.30	2.80	120 1303 0834 00	100 pieces	-



Thread Size 1.8 mm

		Function	Screw head	Material	Colour			Order No.		Matching nut
				Steel	Silver	11.60	2.00	109 4239 0888 05	25 pieces	-
				Steel	Gold	11.60	2.00	109 4245 0888 15	25 pieces	-
				Steel	Black	11.60	2.00	109 4251 0888 25	25 pieces	-



TIPS & TRICKS

Complete 4 jobs in 1!

4-in-1-Screw

used for example:
No. 120 1227

Pro Screwdriver

No. 120 2161

Screw Holder Tweezer

No. 120 2156



approx. 3 minutes each

This is how it works

RIM JOINT
1 THREAD THE SCREW

2 TIGHTEN

3 SNAP OFF

HINGE
1 THREAD THE SCREW

2 TIGHTEN

3 SNAP OFF

4 DONE



Special Screws

Complete 4 jobs in 1!

With the 4-in-1 screw fastening of sunken rim joints and spring hinges will be easier than ever before. The long conical shaped pin makes threading easier and can then be snapped off. Thanks to the self-cutting thread and screw securer no further action is needed.



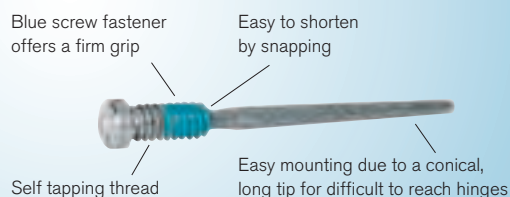





































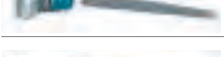

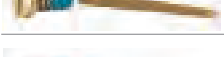

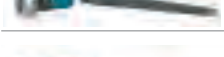





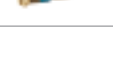

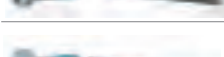













4-in-1 Screws



		Screw head	Material	Colour				Order No.		Matching nut
			Steel	Silver	1.00	12.80/ 2.80	1.40	120 1190 0816 000	50 pieces	-
			Steel	Gold	1.00	12.80/ 2.80	1.40	120 1206 0816 100	50 pieces	-
			Steel	Gun	1.00	12.80/ 2.80	1.40	120 1218 0816 200	50 pieces	-
			Steel	Silver	1.20	14.80/ 4.80	1.80	120 1191 0816 001	50 pieces	-
			Steel	Gold	1.20	14.80/ 4.80	1.80	120 1207 0816 101	50 pieces	-
			Steel	Gun	1.20	14.80/ 4.80	1.80	120 1219 0816 201	50 pieces	-
			Steel	Silver	1.20	15.50/ 5.50	1.80	120 1202 0816 012	50 pieces	-
			Steel	Silver	1.30	14.80/ 4.80	1.80	120 1192 0816 002	50 pieces	-
			Steel	Gold	1.30	14.80/ 4.80	1.80	120 1208 0816 102	50 pieces	-
			Steel	Gun	1.30	14.80/ 4.80	1.80	120 1220 0816 202	50 pieces	-
			Steel	Silver	1.40	13.00/ 3.00	1.80	120 1193 0816 003	50 pieces	-
			Steel	Gold	1.40	13.00/ 3.00	1.80	120 1209 0816 103	50 pieces	-
			Steel	Gun	1.40	13.00/ 3.00	1.80	120 1221 0816 203	50 pieces	-
			Steel	Silver	1.40	14.80/ 4.80	1.80	120 1194 0816 004	50 pieces	-
			Steel	Gold	1.40	14.80/ 4.80	1.80	120 1210 0816 104	50 pieces	-
			Steel	Gun	1.40	14.80/ 4.80	1.80	120 1222 0816 204	50 pieces	-
			Steel	Silver	1.40	13.50/ 3.50	2.00	120 1197 0816 007	50 pieces	-
			Steel	Gold	1.40	13.50/ 3.50	2.00	120 1213 0816 107	50 pieces	-

Special Screws

4-in-1 Screws										
		Screw head	Material	Colour				Order No.		Matching nut
			Steel	Gun	1.40	13.50/ 3.50	2.00	120 1225 0816 207	50 pieces	-
			Steel	Silver	1.40	14.00/ 4.00	2.00	120 1198 0816 008	50 pieces	-
			Steel	Gold	1.40	14.00/ 4.00	2.00	120 1214 0816 108	50 pieces	-
			Steel	Gun	1.40	14.00/ 4.00	2.00	120 1226 0816 208	50 pieces	-
			Steel	Silver	1.40	14.80/ 4.80	2.00	120 1199 0816 009	50 pieces	-
			Steel	Gold	1.40	14.80/ 4.80	2.00	120 1215 0816 109	50 pieces	-
			Steel	Gun	1.40	14.80/ 4.80	2.00	120 1227 0816 209	50 pieces	-
			Steel	Silver	1.40	15.50/ 5.50	2.00	120 1203 0816 013	50 pieces	-
			Steel	Silver	1.50	14.00/ 4.00	1.80	120 1195 0816 005	50 pieces	-
			Steel	Gold	1.50	14.00/ 4.00	1.80	120 1211 0816 105	50 pieces	-
			Steel	Gun	1.50	14.00/ 4.00	1.80	120 1223 0816 205	50 pieces	-
			Steel	Silver	1.50	14.80/ 4.80	1.80	120 1196 0816 006	50 pieces	-
			Steel	Gold	1.50	14.80/ 4.80	1.80	120 1212 0816 106	50 pieces	-
			Steel	Gun	1.50	14.80/ 4.80	1.80	120 1224 0816 206	50 pieces	-
			Steel	Silver	1.50	14.00/ 4.00	2.00	120 1200 0816 010	50 pieces	-
			Steel	Gold	1.50	14.00/ 4.00	2.00	120 1216 0816 110	50 pieces	-
			Steel	Gun	1.50	14.00/ 4.00	2.00	120 1228 0816 210	50 pieces	-
			Steel	Silver	1.50	14.80/ 4.80	2.00	120 1201 0816 011	50 pieces	-
			Steel	Gold	1.50	14.80/ 4.80	2.00	120 1217 0816 111	50 pieces	-
			Steel	Gun	1.50	14.80/ 4.80	2.00	120 1229 0816 211	50 pieces	-

 "Complete 4 jobs in 1!"
(see page F 35)

4-in-1 Screw Assortment

Contents: 7 different 4-in-1 screws (350 pieces)

120 1204
0816 050  43 g

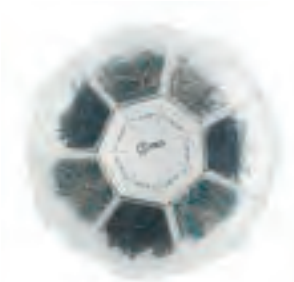

Special Screws

Rimless Frame Screws

You will find the following parts on

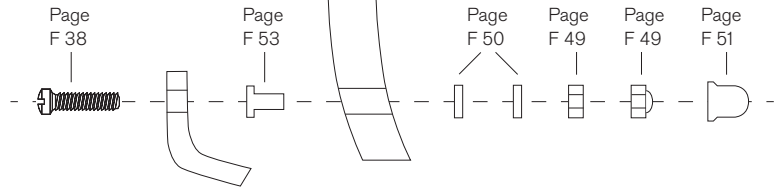

		Screw head	Material	Colour				Order No.		Matching nut
			German Silver	Silver	1.20	12.00	1.80	120 1295 0831 00	100 pieces	120 1277 0822 01TL
			Brass	Gold	1.20	12.00	1.80	120 1296 0831 10	100 pieces	120 1279 0822 02TL
			Brass	Gun	1.20	12.00	1.80	120 1297 0831 20	100 pieces	120 1280 0822 03
			German Silver	Silver	1.20	12.00	2.50	120 1319 0841 01	100 pieces	120 1277 0822 01TL
			German Silver	Gold	1.20	12.00	2.50	120 1321 0841 11	100 pieces	120 1279 0822 02TL
			Steel	Silver	1.20	12.60	2.20	120 1367 0858 00	100 pieces	120 1277 0822 01TL
			Steel	Gold	1.20	12.60	2.20	120 1369 0858 10	100 pieces	120 1279 0822 02TL
			German Silver	Silver	1.20	15.00	1.80	120 1333 0843 00	100 pieces	120 1277 0822 01TL
			German Silver	Silver	1.40	12.00	2.50	120 1318 0841 00	100 pieces	120 1284 0824 01TL
			Brass	Gold	1.40	12.00	2.50	120 1320 0841 10	100 pieces	120 1286 0824 02TL
			German Silver	Gun	1.40	12.00	2.50	120 1322 0841 20	100 pieces	120 1287 0824 03
			Steel	Silver	1.40	12.60	2.20	120 1368 0858 01	100 pieces	120 1284 0824 01TL
			Steel	Gold	1.40	12.60	2.20	120 1370 0858 11	100 pieces	120 1286 0824 02TL
			German Silver	Silver	1.40	15.00	1.80	120 1334 0843 01	100 pieces	120 1284 0824 01TL



		Screw head	Material	Colour				Order No.		Matching nut
			Steel	Silver	1.20	3.40	1.60	120 1419 0882 00	100 pieces	-
			Steel	Gold	1.20	3.40	1.60	120 1420 0882 10	100 pieces	-
			Steel	Silver	1.20	7.00	2.00	120 1421 0883 00	100 pieces	-
			Steel	Silver	1.30	3.50	1.70	120 1416 0880 00	100 pieces	-
			Steel	Gold	1.30	3.50	1.70	120 1417 0880 10	100 pieces	-
			Steel	Silver	1.40	3.60	2.00	120 1422 0884 00	100 pieces	-
			Steel	Silver	1.40	4.40	2.00	120 1423 0884 01	100 pieces	-
			Steel	Silver	1.40	4.70	2.00	120 1424 0884 02	100 pieces	-
			Steel	Silver	1.60	4.00	2.50	120 1185 0811 05	50 pieces	-
			Steel	Silver	1.60	4.60	2.50	120 1186 0811 06	50 pieces	-











Special Screws

























Torx Screws

























Made of steel, available in silver colour and sizes TX2, TX3 and TX4





Torx Screws TX2										
		Screw head	Material	Colour				Order No.		Matching nut
			Steel	Silver	1.00	4.50	1.80	120 1459 0889 00	100 pieces	-

Torx Screws TX3										
		Screw head	Material	Colour				Order No.		Matching nut
			Steel	Silver	1.20	3.00	2.00	120 1432 0886 03	100 pieces	-
			Steel	Silver	1.20	3.50	2.00	120 1433 0886 04	100 pieces	-
			Steel	Silver	1.20	3.90	2.00	109 2223 0886 00	100 pieces	-
			Steel	Silver	1.20	4.00	2.00	120 1434 0886 05	100 pieces	-
			Steel	Silver	1.20	4.40	2.00	109 2224 0886 01	100 pieces	-
			Steel	Silver	1.20	4.90	2.00	109 2225 0886 02	100 pieces	-

Torx Screws TX4										
		Screw head	Material	Colour				Order No.		Matching nut
			Steel	Silver	1.40	3.00	2.00	120 1438 0887 03	100 pieces	-
			Steel	Silver	1.40	3.50	2.00	120 1439 0887 04	100 pieces	-
			Steel	Silver	1.40	3.90	2.00	109 2226 0887 00	100 pieces	-
			Steel	Silver	1.40	4.00	2.00	120 1440 0887 05	100 pieces	-
			Steel	Silver	1.40	4.40	2.00	109 2227 0887 01	100 pieces	-
			Steel	Silver	1.40	4.90	2.00	109 2228 0887 02	100 pieces	-



You will find our Torx drivers on page C 9.

Special Screws

Screws for Plastic Hinges

Made of steel, available colours: silver and gun



Coarse thread especially for plastic

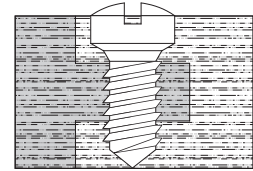

		Screw head	Material	Colour				Order No.		Matching nut
			Steel	Gun	1.20	3.00	2.30	120 1301 0833 20	50 pieces	-
			Steel	Silver	1.40	7.80	2.00	120 1357 0855 00	50 pieces	-
			Steel	Silver	1.40	10.80	2.00	120 1358 0855 01	50 pieces	-
			Steel	Silver	1.50	5.00	2.00	120 1361 0855 04	50 pieces	-
			Steel	Silver	1.60	4.00	2.50	120 1363 0855 06	50 pieces	-
			Steel	Silver	1.60	5.20	2.50	120 1364 0855 07	50 pieces	-
			Steel	Silver	1.60	6.00	2.50	120 1362 0855 05	50 pieces	-
			Steel	Silver	1.60	7.80	2.00	120 1359 0855 02	50 pieces	-
			Steel	Silver	1.60	10.80	2.00	120 1360 0855 03	50 pieces	-

Spring Hinge Screws

Made of steel, available colours: silver, gold and gun



Easy to shorten by snapping



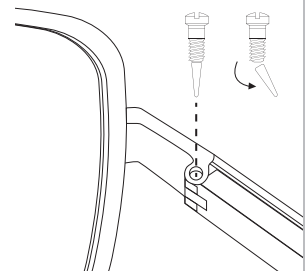

































































Simple to mount due to a conical tip



		Screw head	Material	Colour				Order No.		Matching nut
			Steel	Silver	1.00	5.80/ 2.80	1.40	120 1247 0819 05	100 pieces	-
			Steel	Gold	1.00	5.80/ 2.80	1.40	120 1264 0819 15	100 pieces	-
			Steel	Silver	1.20	5.90/ 3.50	2.00	120 1243 0819 03	100 pieces	-
			Steel	Gold	1.20	5.90/ 3.50	2.00	120 1260 0819 13	100 pieces	-



Special Screws

Spring Hinge Screws										
		Screw head	Material	Colour				Order No.		Matching nut
			Steel	Gun	1.20	5.90/ 3.50	2.00	120 1272 0819 23	100 pieces	-
			Steel	Silver	1.20	7.00/ 4.00	2.00	120 1253 0819 08	100 pieces	-
			Steel	Silver	1.20	7.50/ 4.50	2.00	120 1254 0819 09	100 pieces	-
			Steel	Silver	1.30	6.50/ 3.50	2.00	120 1249 0819 06	100 pieces	-
			Steel	Gold	1.30	6.50/ 3.50	2.00	120 1266 0819 16	100 pieces	-
			Steel	Silver	1.40	6.50/ 3.50	2.00	120 1236 0819 00	100 pieces	-
			Steel	Silver	1.40	7.00/ 4.00	2.00	120 1238 0819 01	100 pieces	-
			Steel	Silver	1.40	7.80/ 4.80	2.00	120 1242 0819 02	100 pieces	-
			Steel	Gold	1.40	6.50/ 3.50	2.00	120 1255 0819 10	100 pieces	-
			Steel	Gold	1.40	7.00/ 4.00	2.00	120 1257 0819 11	100 pieces	-
			Steel	Gold	1.40	7.80/ 4.80	2.00	120 1259 0819 12	100 pieces	-
			Steel	Gun	1.40	6.50/ 3.50	2.00	120 1270 0819 20	100 pieces	-
			Steel	Silver	1.40	8.50/ 5.50	2.00	120 1239 0819 010	100 pieces	-
			Steel	Silver	1.40	9.50/ 6.50	2.00	120 1240 0819 011	100 pieces	-
			Steel	Silver	1.40	10.60/ 3.60	1.80	120 1230 0817 00	100 pieces	-
			Steel	Gold	1.40	10.60/ 3.60	1.80	120 1233 0817 10	100 pieces	-
			Steel	Gun	1.40	10.60/ 3.60	1.80	120 1234 0817 20	100 pieces	-
			Steel	Silver	1.50	6.50/ 3.50	2.00	120 1251 0819 07	100 pieces	-
			Steel	Gold	1.50	6.50/ 3.50	2.00	120 1268 0819 17	100 pieces	-
			Steel	Silver	1.60	6.50/ 3.50	2.00	120 1245 0819 04	100 pieces	-
			Steel	Gold	1.60	6.50/ 3.50	2.00	120 1262 0819 14	100 pieces	-

Special Screws

Spring Hinge Screws with blue Screw Securer









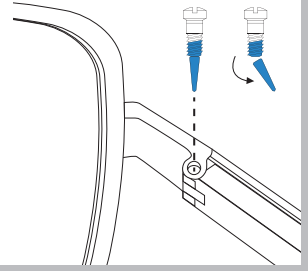













































Made of steel, available colours: silver, gold and gun

Simple to mount due to a conical tip

Blue screw securer offers a firm grip

Easy to shorten by snapping



		Screw head	Material	Colour				Order No.		Matching nut
			Steel	Silver	1.00	5.80/ 2.80	1.40	120 1248 0819 05TL	50 pieces	-
			Steel	Gold	1.00	5.80/ 2.80	1.40	120 1265 0819 15TL	50 pieces	-
			Steel	Silver	1.20	5.90/ 3.50	2.00	120 1244 0819 03TL	50 pieces	-
			Steel	Gold	1.20	5.90/ 3.50	2.00	120 1261 0819 13TL	50 pieces	-
			Steel	Gun	1.20	5.90/ 3.50	2.00	120 1273 0819 23TL	50 pieces	-
			Steel	Silver	1.30	6.50/ 3.50	2.00	120 1250 0819 06TL	50 pieces	-
			Steel	Gold	1.30	6.50/ 3.50	2.00	120 1267 0819 16TL	50 pieces	-
			Steel	Silver	1.40	6.50/ 3.50	2.00	120 1237 0819 00TL	50 pieces	-
			Steel	Silver	1.40	7.00/ 4.00	2.00	120 1241 0819 01TL	50 pieces	-
			Steel	Gold	1.40	6.50/ 3.50	2.00	120 1256 0819 10TL	50 pieces	-
			Steel	Gold	1.40	7.00/ 4.00	2.00	120 1258 0819 11TL	50 pieces	-
			Steel	Gun	1.40	6.50/ 3.50	2.00	120 1271 0819 20TL	50 pieces	-
			Steel	Silver	1.50	6.50/ 3.50	2.00	120 1252 0819 07TL	50 pieces	-
			Steel	Gold	1.50	6.50/ 3.50	2.00	120 1269 0819 17TL	50 pieces	-
			Steel	Silver	1.60	6.50/ 3.50	2.00	120 1246 0819 04TL	50 pieces	-
			Steel	Gold	1.60	6.50/ 3.50	2.00	120 1263 0819 14TL	50 pieces	-



Special Screws

Hilco Logic® Screws



























































In 1998 Hilco simplified eyewear repair with the Logic® nose pad.

10,000 customers and 10 million pads later, we've brought Logic® to the optical screw.

The Logic® screw system contains just 6 eyewire/hinge screws in various diameters that replace every other screw type in your inventory, including spring hinge and self-tapping.

- Reduces inventory by 80 %
- Breaks clean at the right length
- Perfect for spring hinges and lens insertion
- With Tight Bond™ screw securer



		Screw head	Material	Colour				Order No.		Matching nut
			Steel	Silver	1.20	11.60	2.00	109 4234 0888 00	25 pieces	-
			Steel	Gold	1.20	11.60	2.00	109 4240 0888 10	25 pieces	-
			Steel	Black	1.20	11.60	2.00	109 4246 0888 20	25 pieces	-
			Steel	Silver	1.30	11.60	2.00	109 4235 0888 01	25 pieces	-
			Steel	Gold	1.30	11.60	2.00	109 4241 0888 11	25 pieces	-
			Steel	Black	1.30	11.60	2.00	109 4247 0888 21	25 pieces	-
			Steel	Silver	1.40	11.60	2.00	109 4236 0888 02	25 pieces	-
			Steel	Gold	1.40	11.60	2.00	109 4242 0888 12	25 pieces	-
			Steel	Black	1.40	11.60	2.00	109 4248 0888 22	25 pieces	-
			Steel	Silver	1.50	11.60	2.00	109 4237 0888 03	25 pieces	-
			Steel	Gold	1.50	11.60	2.00	109 4243 0888 13	25 pieces	-
			Steel	Black	1.50	11.60	2.00	109 4249 0888 23	25 pieces	-
			Steel	Silver	1.60	11.60	2.00	109 4238 0888 04	25 pieces	-
			Steel	Gold	1.60	11.60	2.00	109 4244 0888 14	25 pieces	-
			Steel	Black	1.60	11.60	2.00	109 4250 0888 24	25 pieces	-
			Steel	Silver	1.80	11.60	2.00	109 4239 0888 05	25 pieces	-
			Steel	Gold	1.80	11.60	2.00	109 4245 0888 15	25 pieces	-
			Steel	Black	1.80	11.60	2.00	109 4251 0888 25	25 pieces	-

Special Screws

Screws with transparent Nylon Securer

Made of steel, available colours: silver and gold

Transparent nylon inlay

Self tapping thread

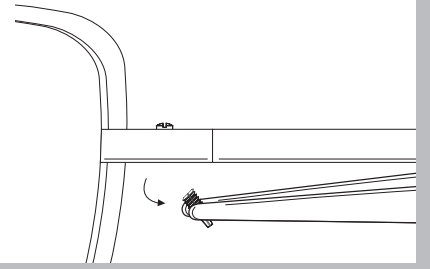

		Screw head	Material	Colour				Order No.		Matching nut
			Steel	Silver	1.30	11.50	1.80	120 1383 0861 01	50 pieces	-
			Steel	Gold	1.30	11.50	1.80	120 1384 0861 11	50 pieces	-
			Steel	Silver	1.40	11.50	1.80	120 1385 0862 01	50 pieces	-
			Steel	Gold	1.40	11.50	1.80	120 1386 0862 11	50 pieces	-
			Steel	Silver	1.50	11.50	1.80	120 1387 0863 01	50 pieces	-
			Steel	Gold	1.50	11.50	1.80	120 1388 0863 11	50 pieces	-

Temple Screws

Made of steel, available in silver

The black nylon sleeve ensures a smooth movement of the temple

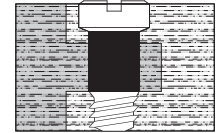

		Screw head	Material	Colour				Order No.		Matching nut
			Steel	Silver	1.40	3.00	2.00	120 1180 0811 00	50 pieces	-
			Steel	Silver	1.40	3.50	2.00	120 1181 0811 01	50 pieces	-
			Steel	Silver	1.40	4.00	2.00	120 1182 0811 02	50 pieces	-
			Steel	Silver	1.40	4.50	2.00	120 1183 0811 03	50 pieces	-
			Steel	Silver	1.60	3.50	2.50	120 1184 0811 04	50 pieces	-
			Steel	Silver	1.60	4.00	2.50	120 1185 0811 05	50 pieces	-
			Steel	Silver	1.60	4.60	2.50	120 1186 0811 06	50 pieces	-

Special Screws

Screws with black Screw Securer

The black securing ring wedges to give a firm grip



Phillips/ slotted combination for a free screwdriver selection

Material: steel

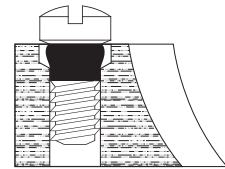

		Screw head	Material	Colour				Order No.		Matching nut
			Steel	Silver	1.40	2.80	1.80	120 1347 0851 01	100 pieces	-
			Steel	Silver	1.40	3.30	2.00	120 1401 0869 01	100 pieces	-
			Steel	Silver	1.40	3.40	1.80	120 1348 0851 02	100 pieces	-
			Steel	Silver	1.40	3.70	2.00	120 1402 0869 02	100 pieces	-
			Steel	Silver	1.40	3.90	2.00	120 1400 0869 00	100 pieces	-
			Steel	Silver	1.40	4.00	1.80	120 1349 0851 03	100 pieces	-
			Steel	Silver	1.40	4.20	2.00	120 1403 0869 03	100 pieces	-
			Steel	Silver	1.40	4.30	1.80	120 1346 0851 00	100 pieces	-

Screws with blue Tuflock Securer

Available in silver



Reusable due to Tuflock coating on thread of screw

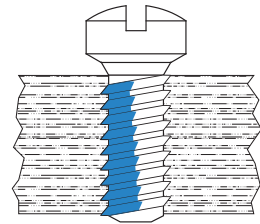

		Function	Screw head	Material	Colour				Order No.		Matching nut
				German Silver	Silver	1.00	4.00	1.40	120 1471 0896 00TL	50 pieces	-
				Steel	Silver	1.40	6.00	1.80	120 1381 0860 58TL	50 pieces	-
				Steel	Silver	1.40	6.50	1.80	120 1376 0860 30TL	50 pieces	-
				Steel	Silver	1.50	5.20	1.80	120 1325 0842 00TL	50 pieces	-
				Steel	Silver	1.60	5.20	1.80	120 1328 0842 01TL	50 pieces	-

Screw Assortment

Contents: 28 different screws and nuts (2,800 pieces)

120 1465
0890 16



Our small parts organiser boxes can be found on page G 12 and G 13.

You will receive all assortments with hinged boxes. We reserve the right to change the assortment.

Screw Assortment Gun-Coloured

Contents: 13 of the most used screws and nuts, altogether 1,300 pieces, 2 empty boxes

120 1466
0890 17



Screw Assortment

In organiser box system No. 120 1816 (see catalogue page G 12).

Contents: 7 of the most used screws and nuts, altogether 700 pieces,
1 empty box

120 1464
0890 10



Rimless Frames Assortment

Contents: 12 of the most used screws, nuts, washers and sleeves
(1,300 pieces)

120 1467
0890 18

















































You will receive all assortments with hinged boxes. We reserve the right to change the assortment.



























Washers Assortment

Contents: 8 of the most used washers (1,000 pieces)

120 1051
0745 50

















Nuts									
		Style	Material	Colour			Order No.		Matching nut driver
			German Silver	Silver	1.20	2.50	120 1276 0822 01	100 pieces	120 2342 1746 00
			German Silver	Silver	1.20	2.50	120 1277 0822 01TL	100 pieces	120 2342 1746 00
			Brass	Gold	1.20	2.50	120 1278 0822 02	100 pieces	120 2342 1746 00
			Brass	Gold	1.20	2.50	120 1279 0822 02TL	100 pieces	120 2342 1746 00
			German Silver	Gun	1.20	2.50	120 1280 0822 03	100 pieces	120 2342 1746 00
			German Silver	Silver	1.30	2.50	120 1281 0823 01	100 pieces	120 2342 1746 00
			German Silver	Gun	1.30	2.50	120 1282 0823 03	100 pieces	120 2342 1746 00
			German Silver	Silver	1.40	2.50	120 1283 0824 01	100 pieces	120 2342 1746 00
			German Silver	Silver	1.40	2.50	120 1284 0824 01TL	100 pieces	120 2342 1746 00
			Brass	Gold	1.40	2.50	120 1285 0824 02	100 pieces	120 2342 1746 00
			Brass	Gold	1.40	2.50	120 1286 0824 02TL	100 pieces	120 2342 1746 00
			German Silver	Gun	1.40	2.50	120 1287 0824 03	100 pieces	120 2342 1746 00
			German Silver	Silver	1.50	2.50	120 1294 0830 01	100 pieces	120 2342 1746 00
			German Silver	Silver	1.60	2.60	120 1300 0833 01	100 pieces	120 2350 1767 00

Dome Nuts									
		Style	Material	Colour			Order No.		Matching nut driver
			German Silver	Silver	1.20	2.20	120 1312 0839 00	100 pieces	120 2348 1749 00
			Brass	Gold	1.20	2.20	120 1313 0839 10	100 pieces	120 2348 1749 00
			German Silver	Gun	1.20	2.20	120 1314 0839 20	100 pieces	120 2348 1749 00
			Steel	Silver	1.20	2.40	120 1298 0832 00	100 pieces	120 2350 1767 00
			Steel	Gold	1.20	2.40	120 1299 0832 10	100 pieces	120 2350 1767 00
			German Silver	Silver	1.40	2.20	120 1315 0840 00	100 pieces	120 2348 1749 00
			Brass	Gold	1.40	2.20	120 1316 0840 10	100 pieces	120 2348 1749 00

 Screw securer



Dome Nuts

		Style	Material	Colour			Order No.		Matching nut driver
			German Silver	Gun	1.40	2.20	120 1317 0840 20	100 pieces	120 2348 1749 00
			Steel	Silver	1.40	2.40	120 1307 0838 00	100 pieces	120 2350 1767 00
			Steel	Gold	1.40	2.40	120 1311 0838 10	100 pieces	120 2350 1767 00





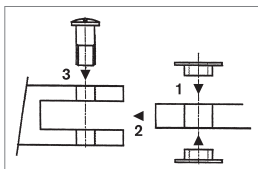



















Special Washers for Titanium Temples



























		Schematic side view	Material	Colour			Order No.	
			Steel	Silver	1.20	2.80	120 1027 0745 07	100 pieces
			Steel	Silver	1.40	2.80	120 1028 0745 08	100 pieces



The washer prevents direct contact between the hinge and the temple rolls. Follow the 3 illustrated steps to assemble. First place the washers at the temple roll, then attach the temple to the hinge and then fasten the screw. The temples can then move freely and without friction.

Washers for Rimless Frames











		Material	Colour			Order No.	
		German Silver for screws with conical heads	Silver	1.20	2.80	120 1030 0745 10	100 pieces
		Brass for screws with conical heads	Gold	1.20	2.80	120 1031 0745 11	100 pieces
		German Silver	Silver	1.20	2.50	109 8816 0745 20	100 pieces
		German Silver	Gold	1.20	2.50	120 1034 0745 14	100 pieces
		German Silver	Gun	1.20	2.50	120 1048 0745 30	100 pieces
		Plastic	Transparent	1.30	2.60	120 1024 0745 00	150 pieces
		German Silver	Silver	1.30	2.50	120 1041 0745 21	100 pieces
		German Silver	Gold	1.30	2.50	120 1035 0745 15	100 pieces
		Plastic	Transparent	1.40	2.80	120 1026 0745 02	150 pieces
		German Silver	Silver	1.40	2.50	109 8817 0745 22	100 pieces

Washers for Rimless Frames							
		Material	Colour			Order No.	
		German Silver	Gold	1.40	2.50	120 1036 0745 16	100 pieces
		German Silver	Gun	1.40	2.80	120 1049 0745 32	100 pieces
		German Silver for screws with conical heads	Silver	1.40	2.80	120 1029 0745 09	100 pieces
		German Silver	Silver	1.50	2.50	120 1043 0745 23	100 pieces
		German Silver	Gold	1.50	2.50	120 1037 0745 17	100 pieces
		Plastic	Transparent	1.60	3.00	120 1033 0745 13	150 pieces
		German Silver for reach nuts No. 109 2219	Silver	1.65	2.70	120 1044 0745 24	100 pieces
		German Silver for reach nuts No. 109 2220	Gold	1.65	2.70	120 1038 0745 18	100 pieces
		German Silver for reach nuts No. 109 2221	Silver	1.85	2.90	120 1045 0745 25	100 pieces
		German Silver for reach nuts No. 109 2222	Gold	1.85	2.90	120 1039 0745 19	100 pieces
		Plastic	Transparent	2.00	3.50	120 1050 0745 33	150 pieces



You will find our washer assortment No. 120 1051 on page F 48.

Reach Nuts										
		Style	Material	Colour				Order No.		Matching nut driver
			German Silver	Silver	1.20	4.00	2.50	109 2219 0844 00	100 pieces	120 2342 1746 00
			Brass	Gold	1.20	4.00	2.50	109 2220 0844 10	100 pieces	120 2342 1746 00
			German Silver	Silver	1.40	4.00	2.50	109 2221 0845 00	100 pieces	120 2342 1746 00
			Brass	Gold	1.40	4.00	2.50	109 2222 0845 10	100 pieces	120 2342 1746 00

Caps for Rimless Frame Screws								
		Material	Colour				Order No.	
		Plastic	Transparent	1.20	2.50	3.50	120 1107 0771 22	100 pieces
		Plastic	Transparent	1.40	2.50	3.50	120 1108 0771 23	100 pieces























































Premium Sleeves from frey & winkler

- High quality basic materials
- Product certified according to ISO 9001
- High dimensional accuracy
- Produced using the latest technology
- Maximum durability
- Colour stability
- No flashes

frey & winkler
CREATIVE SILICONE PRECISION

Sleeves for Rimless Frames

		Material	Colour	Material quality			Order No.	
		Plastic	Transparent	Medium soft	0.80	1.30	120 1112 0771 27	50 pieces
		Plastic	Transparent	Medium soft	0.80	1.40	120 1094 0771 04	50 pieces
		Plastic	Transparent	Soft	0.80	1.40	120 1095 0771 05	50 pieces
		Plastic	Transparent	Medium hard	0.80	1.40	120 1096 0771 06	50 pieces
		Plastic	Transparent	Soft open version	0.80	1.40	120 1100 0771 10	50 pieces
		Plastic	Transparent	Medium hard open version	0.80	1.40	120 1101 0771 11	50 pieces
		Plastic	Transparent	Medium soft open version	0.80	1.40	120 1103 0771 12	50 pieces
		Plastic	Transparent	Medium soft	0.80	1.50	120 1113 0771 28	50 pieces
		Plastic	Transparent	Soft	1.00	1.80	120 1097 0771 07	50 pieces
		Plastic	Transparent	Medium hard	1.00	1.80	120 1098 0771 08	50 pieces
		Plastic	Transparent	Medium soft	1.00	1.80	120 1099 0771 09	50 pieces

Sleeves for Rimless Frames									
		Schematic side view	Material	Colour	Material quality			Order No.	
			Plastic	Transparent		1.20	2.80	120 1104 0771 13	100 pieces
			Plastic	Transparent		1.40	2.80	120 1105 0771 14	100 pieces
			Plastic	Transparent	Hard	1.00	1.80	109 2671 0771 21	50 pieces
			Plastic	Transparent	Hard	0.80	1.50	120 1109 0771 24	50 pieces
			Plastic	Transparent	Hard	0.80	1.40	120 1110 0771 25	50 pieces
			Plastic	Transparent	Hard	0.80	1.50	109 2672 0771 26	50 pieces
			Plastic	Transparent	Soft	0.80	1.60	120 1115 0771 30	50 pieces
			Plastic	Transparent	Hard	1.00	1.80	120 1114 0771 29	50 pieces

Sleeves Assortment

Contents: 7 different sleeves for rimless frames (350 pieces)

108 0775
0771 50

 28 g



Hinges

Explanation on hinges:



Hinge width



Hole distance



Dimensions
(width x depth or
width x height x depth)



Inclination



Milling between
rolls and
thickness of rolls



Thread size



Total length



Packing unit:
piece or pair



Hinge length



Picture enlarged
(200 %)



Head diameter



Hinge roll radius



Picture actual size
(100 %)



Pin diameter

- All dimensions in mm
- Changes of sizes reserved



All double rolled hinges will be delivered with matching screws.

Solder Hinges

Middle part		Temple part							Order No.	
left	right									
			2.5	0.75-0.75	5.0	1.8	0°	1.4	120 0565 0400 01	10 pieces
			2.5	0.75-0.75	5.0	1.8	0°	1.4	120 0566 0400 02	10 pieces
			2.5	1.0	5.0	1.8	0°	1.4	120 0567 0400 10	10 pieces
			3.0	0.9-0.9	5.0	1.8	0°	1.4	120 0570 0401 01	10 pieces
			3.0	0.9-0.9	5.0	1.8	0°	1.4	120 0571 0401 02	10 pieces
			3.0	1.2	5.0	1.8	0°	1.4	120 0572 0401 10	10 pieces
			3.0	0.9-0.9	5.0	1.6	0°	1.4	120 0574 0402 01	10 pieces
			3.0	0.9-0.9	5.0	1.6	0°	1.4	120 0575 0402 02	10 pieces
			3.5	1.0-1.0	3.95	1.6	0°	1.4	120 0576 0403 01	10 pieces
			3.5	1.0-1.0	3.95	1.6	0°	1.4	120 0577 0403 02	10 pieces
			3.5	1.05-1.05	5.0	1.8	0°	1.4	120 0578 0404 01	10 pieces
			3.5	1.05-1.05	5.0	1.8	0°	1.4	120 0579 0404 02	10 pieces
			3.5	1.4	5.0	1.8	0°	1.4	120 0580 0404 10	10 pieces

Hinges

Spring Hinge Sets								
Middle part left	Middle part right	Temple part					Order No.	
			3.0	0.8-0.8	0°	1.2	120 0611 0441 10	5 pairs
			3.0	0.8-0.8	0°	1.2		
			3.0	1.3	0°	-		
			3.3	0.9-0.9	6°	1.2	120 0613 0442 10	5 pairs
			3.3	0.9-0.9	6°	1.2		
			3.0	1.3	6°	-		

Inner Spring for Flex Hinge						
	Material	Colour			Order No.	
	German Silver	Silver	0.8	1.4	120 0614 0443 00	5 pieces
	German Silver	Silver	1.0	1.4	120 0615 0443 01	5 pieces
	German Silver	Silver	1.2	1.4	120 0616 0443 02	5 pieces
	German Silver	Silver	1.4	1.4	120 0617 0443 03	5 pieces























Hinges Assortment

Contents: Solder hinges 120 0570-72 (10 pieces each)
 rivet hinges 120 0585-87 (10 pieces each)
 rivets 120 1504 (100 pieces)
 (160 pieces)

120 0568
0400 50



Hinges

Rivet Hinges										
Middle part		Temple part							Order No.	
left	right	left	right							
				3.0	1.0	2.5	6°	1.4	120 0581 0405 01	10 pieces
				3.0	1.0	2.5	6°	1.4	120 0582 0405 02	10 pieces
				3.0	0.8-0.8	2.5	6°	1.4	120 0583 0405 11	10 pieces
				3.0	0.8-0.8	2.5	6°	1.4	120 0584 0405 12	10 pieces
				3.0	1.2	2.5	0°	1.4	120 0585 0406 00	10 pieces
				3.0	0.9-0.9	2.5	0°	1.4	120 0586 0406 11	10 pieces
				3.0	0.9-0.9	2.5	0°	1.4	120 0587 0406 12	10 pieces
				3.5	1.4	2.5	6°	1.4	120 0588 0407 01	10 pieces
				3.5	1.4	2.5	6°	1.4	120 0589 0407 02	10 pieces
				3.5	0.9-0.9	2.5	6°	1.4	120 0590 0407 11	10 pieces
				3.5	0.9-0.9	2.5	6°	1.4	120 0591 0407 12	10 pieces
				6.0	0.8-0.8	2.5	6°	1.4	120 0592 0408 01	10 pieces
				6.0	0.8-0.8	2.5	6°	1.4	120 0593 0408 02	10 pieces
				6.0	0.8-0.8	2.5	6°	1.4	120 0594 0408 03	10 pieces
				6.0	0.8-0.8	2.5	6°	1.4	120 0595 0408 04	10 pieces
				6.0	1.1-0.7-1.1	2.5	6°	1.4	120 0596 0408 11	10 pieces
				6.0	1.1-0.7-1.1	2.5	6°	1.4	120 0597 0408 12	10 pieces

Hinges

Hidden Hinges								
Middle part straight	Middle part left	Middle part right					Order No.	
			5.0	1.0	0°	1.4	109 8939 0409 00	10 pieces
			5.0	1.2	0°	1.4	109 8940 0412 00	10 pieces
			5.0	1.4	0°	1.4	109 8941 0414 00	10 pieces
			4.4	1.3	0°	1.4	120 0601 0416 00	10 pieces
			3.5	1.4	0°	1.4	120 0602 0417 00	10 pieces
			3.5	1.6	0°	1.4	120 0603 0418 00	10 pieces
			7.0	1.6	0°	1.4	120 0604 0422 00	10 pieces
			3.3	0.9-0.9	0°	1.4	120 0607 0424 01	10 pieces
			3.3	0.9-0.9	0°	1.4	120 0608 0424 02	10 pieces
			4.5	1.0-1.0	0°	1.4	120 0609 0425 01	10 pieces
			4.5	1.0-1.0	0°	1.4	120 0610 0425 02	10 pieces

Rim Joints								
		Material	Colour	Application			Order No.	
		German Silver	Silver	Flat, for eyewire 1.80 to 2.50 mm. Has to be cut after soldering, with screws.	1.40	2.60 x 2.80 x 3.40	120 1475 0898 01	10 pieces
		German Silver	Silver	Flat, for eyewire 1.80 to 2.30 mm. Has to be cut after soldering, with screws.	1.40	2.40 x 4.50	120 1476 0898 02	10 pieces

Rivets								
		Material	Colour				Order No.	
		German Silver	Silver	25.00	1.70	0.70: 1.70	120 1505 0906 00	200 pieces
		German Silver	Silver	10.00	1.80	1.20	120 1504 0904 03	100 pieces

The B&S Temples and Temple Ends Range:

- Extensive selection
- For all applications
- Easy to find. Simple to order



Ordering in 3 Steps

1. Select form and material
2. Select the length
3. Select colour and diameter

Worth Knowing

f&w & The Icons guarantees:

- High-quality basic materials
- Maximum durability
- Colour stability
- Highest precision

frey & winkler
CREATIVE SILICONE PRECISION

f&w Made in Germany Temple Ends offers you:

- Small cast points for better wear comfort
- Rounded edges
- High dimensional accuracy and high quality of the composite materials
- Certified according to ISO 9001

Overview for Simple Selection

	Standard Temple End <ul style="list-style-type: none"> ▪ Length: 64 mm ▪ Length: 65 mm ▪ Length: 67 mm ▪ Length: 69 mm ▪ Length: 70 mm ▪ Length: 75 mm – To extend Temples 	F 60 F 60–F 61 F 62 F 62 F 62 F 63
	Silicone Temple End <ul style="list-style-type: none"> ▪ Length: 65 mm ▪ Length: 67 mm ▪ Length: 70 mm 	F 63 F 63 F 63
	Temple End with Square Opening <ul style="list-style-type: none"> ▪ Length: 61 mm ▪ Length: 63 mm – For Straight Temples ▪ Length: 63 mm – Flat, Square Opening ▪ Length: 70 mm – Flat Opening 	F 64 F 64 F 64 F 64
	Temple End for ic! berlin Frames <ul style="list-style-type: none"> ▪ Length: 85 ▪ Tube Sets 	F 65 F 65
	Sports Temple Ends <ul style="list-style-type: none"> ▪ Sports Temple Ends made of Silicone ▪ Sports Temple End ▪ MEGALOCK Temple End ▪ Non-slip Temple End 	F 66–F 69 F 70 F 70 F 71–F 73
	Windsor Rim <ul style="list-style-type: none"> ▪ Outer Profile ▪ W-Profile 	F 74 F 74
	Long Temple Ends <ul style="list-style-type: none"> ▪ Length: 135 mm – Thin Type ▪ Length: 135 mm – Symmetrical Shape 	F 75 F 75
	Heat Shrink Tubes <ul style="list-style-type: none"> ▪ Heat Shrink Tubes ▪ Heat Shrink Tube Assortment 	F 76–F 77 F 77
	Temples <ul style="list-style-type: none"> ▪ Temples with Flex Hinges – Nickel Free ▪ Temples with RAL Joint (American Joint) ▪ Standard Temples – Nickel Free ▪ Acetate Temples 	F 78 F 78 F 79 F 79–F 80
	Spare Parts for Rimless Frames <ul style="list-style-type: none"> ▪ Spare Parts for Rimless Frames with Sleeves Mounting ▪ Replacement Set for Rimless Frames with Sleeves Mounting ▪ Replacement Set for Rimless Frames with Screw Mounting 	F 81–F 82 F 81 F 83



Standard Temple End

Length: 64 mm

PP Temple End – Small Opening

Sealed end for high quality titanium frames.

frey & winkler
CREATIVE SILICONE PRECISION





	Transparent	f&w	∅ 1.0 mm	120 0959 0726 27	10 pieces
	Anthracite transparent	f&w	∅ 1.0 mm	120 0960 0726 28	10 pieces

Length: 65 mm

Temple End – Classic Shape

	Black		∅ 1.45 mm	120 0912 0712 41	10 pieces
			∅ 1.6 mm	120 0913 0712 61	10 pieces





Acetate Temple End – Thin Type

	Black		∅ 1.25 mm	120 0896 0711 21	10 pieces
			∅ 1.45 mm	120 0900 0711 41	10 pieces
			∅ 1.6 mm	120 0904 0711 61	10 pieces
			∅ 1.7 mm	120 0908 0711 71	10 pieces
			∅ 1.9 mm	120 0910 0711 91	10 pieces
	Brown		∅ 1.25 mm	120 0897 0711 22	10 pieces
			∅ 1.45 mm	120 0901 0711 42	10 pieces
			∅ 1.6 mm	120 0905 0711 62	10 pieces
			∅ 1.7 mm	120 0909 0711 72	10 pieces
			∅ 1.9 mm	120 0911 0711 92	10 pieces
	Havana		∅ 1.25 mm	120 0898 0711 23	10 pieces
			∅ 1.45 mm	120 0902 0711 43	10 pieces
			∅ 1.6 mm	120 0906 0711 63	10 pieces
	Transparent		∅ 1.25 mm	120 0899 0711 24	10 pieces
			∅ 1.45 mm	120 0903 0711 44	10 pieces
			∅ 1.6 mm	120 0907 0711 64	10 pieces



Standard Temple End

Length: 65 mm

Acetate Temple End – Symmetrical Shape

 Black	∅ 1.25 mm	120 0919 0714 21	10 pieces
	∅ 1.45 mm	120 0920 0714 41	10 pieces
	∅ 1.6 mm	120 0925 0714 61	10 pieces
	∅ 1.7 mm	120 0930 0714 71	10 pieces
 Brown	∅ 1.45 mm	120 0921 0714 42	10 pieces
	∅ 1.6 mm	120 0926 0714 62	10 pieces
	∅ 1.7 mm	120 0931 0714 72	10 pieces
 Havana	∅ 1.45 mm	120 0922 0714 43	10 pieces
	∅ 1.7 mm	120 0932 0714 73	10 pieces
 Transparent	∅ 1.45 mm	120 0923 0714 44	10 pieces
	∅ 1.6 mm	120 0928 0714 64	10 pieces
	∅ 1.7 mm	120 0933 0714 74	10 pieces
 Grey	∅ 1.45 mm	120 0924 0714 47	10 pieces
	∅ 1.6 mm	120 0929 0714 67	10 pieces



Temple End – Symmetrical Shape

 Black	∅ 1.2 mm	120 0885 0709 21	10 pieces
	∅ 1.45 mm	120 0888 0709 41	10 pieces
	∅ 1.6 mm	120 0891 0709 61	10 pieces
 Brown	∅ 1.2 mm	120 0886 0709 22	10 pieces
	∅ 1.45 mm	120 0889 0709 42	10 pieces
	∅ 1.6 mm	120 0892 0709 62	10 pieces
 Havana	∅ 1.2 mm	120 0887 0709 23	10 pieces
	∅ 1.45 mm	120 0890 0709 43	10 pieces
	∅ 1.6 mm	120 0893 0709 63	10 pieces

Standard Temple End



Length: 67 mm

Acetate Temple End – Small Opening

	Black	∅ 1.0 mm	120 0914 0713 01	10 pieces
	Brown	∅ 1.0 mm	120 0915 0713 02	10 pieces
	Transparent	∅ 1.0 mm	120 0916 0713 04	10 pieces

Length: 69 mm

Acetate Temple End – Small Opening



	Black	∅ 1.1 mm	130 0702 0713 10	10 pieces
	Brown	∅ 1.1 mm	130 0703 0713 11	10 pieces
	Transparent	∅ 1.1 mm	130 0704 0713 12	10 pieces

Length: 70 mm



Temple End Hard

	Transparent	∅ 1.1 mm	120 0961 0727 27	10 pieces
---	-------------	----------	----------------------------	-----------

Temple End – Classic Shape

	Transparent	∅ 1.5 mm	120 1159 0794 08	10 pieces
	Black	∅ 1.5 mm	120 1160 0794 10	10 pieces
	Dark brown	∅ 1.5 mm	120 1161 0794 16	10 pieces

Temple End – Small Opening



	Black	∅ 0.9 mm	120 1082 0754 01	10 pieces
	Brown	∅ 0.9 mm	120 1083 0754 16	10 pieces
	Transparent	∅ 0.9 mm	120 1084 0754 27	10 pieces

Standard Temple End

Length: 75 mm

Temple End – Classic Shape to extend Temples

To extend frame temples by at least 10 mm.



	Black	∅ 1.4 mm	120 1166 0797 10	10 pieces
	Dark brown	∅ 1.4 mm	120 1167 0797 16	10 pieces
	Transparent	∅ 1.4 mm	120 1168 0797 27	10 pieces

Silicone Temple End

Length: 65 mm



Silicone Temple End – Small Opening

One end closed for metal temple 0.9 to 1.5 mm, hypo-allergenic, easy to fit, just moisten with liquid soap.

	Black	∅ 0.9 to 1.5 mm flexible	120 1085 0756 01	10 pieces
	Brown	∅ 0.9 to 1.5 mm flexible	120 1086 0756 16	10 pieces
	Transparent	∅ 0.9 to 1.5 mm flexible	120 1087 0756 27	10 pieces

Length: 67 mm

Silicone Temple End – Small Opening

	Black	∅ 0.9 to 1.1 mm flexible	120 0937 0716 01	10 pieces
	Transparent	∅ 0.9 to 1.1 mm flexible	120 0939 0716 04	10 pieces

Length: 70 mm

Silicone Temple End

	Black		∅ 1.0 mm	120 1164 0795 11	10 pieces
			∅ 1.4 mm	120 1162 0795 01	10 pieces
	Dark brown		∅ 1.0 mm	120 1165 0795 17	10 pieces
			∅ 1.4 mm	120 1163 0795 07	10 pieces



Temple End with Square Opening







Length: 61 mm

Silicone Temple End

	 1.5 x 1.0 mm	120 0977 0732 01	10 pieces
Black			
	 1.5 x 1.0 mm	120 0978 0732 02	10 pieces
Brown			
	 1.5 x 1.0 mm	120 0979 0732 04	10 pieces
Transparent			

Length: 63 mm

Silicone Temple End – For Straight Temples

	  2.6 x 1.5 mm	120 0935 0715 01	10 pieces
Black			
	  2.6 x 1.5 mm	120 0936 0715 02	10 pieces
Brown			





Temple End – Flat, Square Opening

	 4.0 x 1.3 mm	120 1157 0789 00	10 pieces
Black			

Length: 70 mm

Temple End – Flat Opening

For thin metal temples.

	 2.5 x 1.3 mm	120 1088 0757 00	10 pieces
Black			
	 2.5 x 1.3 mm	120 1089 0757 01	10 pieces
Brown			

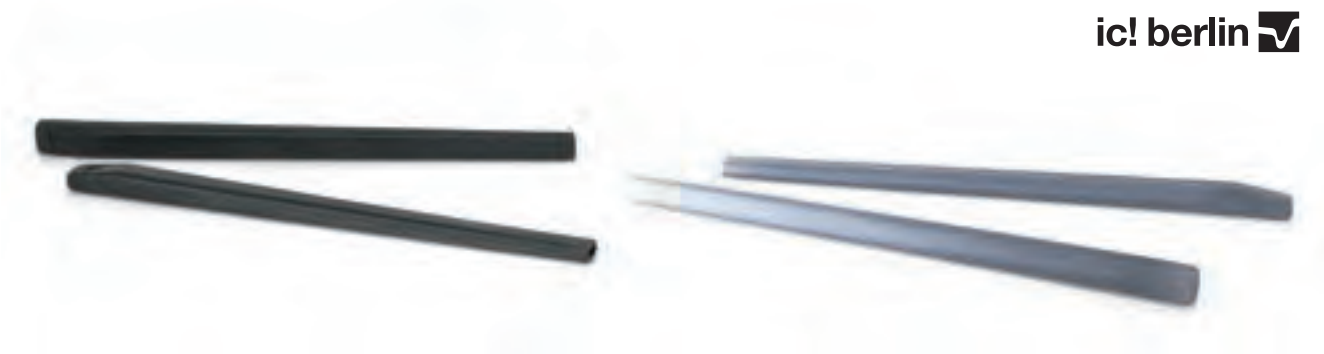

Length: 85 mm

ic! berlin Temple Tip

Material: Thermoplastic elastomer



Black

 2.8 x 1.0 mm

120 1134
0782 02

2 pairs



Grey

 2.8 x 1.0 mm

120 1135
0782 03

2 pairs

ic! berlin Tube Set Classic

- Length nose tubes: 19 mm
- Length temple tubes: 88 mm
- Temple diameter: 6 mm
- Color: Transparent
- Material: Silicone

120 1125
0780 01

 5 pieces

ic! berlin Tube Set Large

- Length nose tubes: 13 mm
- Length temple tubes: 94 mm
- Temple diameter: 10 mm
- Colour: Transparent
- Material: Silicone

120 1126
0780 13

 5 pieces





TIPS & TRICKS

EASY MOUNTING OF SPORT TEMPLE ENDS

Nothing Slips!

Sport Temple Ends

used for example: No. 120 0985

Universal Pen

No.120 3040

Double Joint Front Cutter

No. 120 2096

Precision File

No. 120 2395

Frame Heater

No. 120 3171



approx. 5 minutes



This is how it works

Preparations for all sport temple tips

1 MARKING



2 CUTTING



3 CUTTING NOTCHES



Applying the sport temple ends No. 120 0985–93, 120 0994–99, 120 0940–44, 120 0946–49, 120 0964 and 121 0488–92, 121 0494–500 **with heating procedure**

4 HEATING



5 PUSHING



6 COOLING



Applying the sport temple ends No. 120 0974, -76 **with cold procedure**

4 COLD PUSHING



5 DONE



OPTIONAL: PRESSING



TIP 1: If the temple is thinner than 1.3 mm use a vice to flatten and widen the end.

TIP 2: Sport temple ends on plastic temples? Expose the metal inlay! Cut off 1 cm only of the plastic on the temple and detach it.



Application videos can be found at www.youtube.com/user/BreitfeldSchliekert



Sports Temple Ends made of Silicone

For supplementary application on metal temples and inserts of plastic temples.

Assembling range: approx. 1.3 to 1.4 mm

Ø inner: 1.3 mm

Ø outer: 4.0 mm

Thickness of silicone coating: 0.6 mm

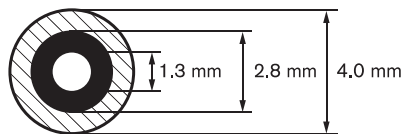

■ Plastic

▨ Silicone

📦 1 pair

Children: Length 80 mm

Adults: Length 95 mm

Order No.	Colour	Order No.	Colour
121 0488 0749 01	Black	120 0974 0731 01	Black
121 0489 0749 02	Grey	120 0976 0731 16	Dark brown
121 0490 0749 03	Petrol		
121 0491 0749 04	Purple		
121 0492 0749 05	Red		
121 0494 0749 06	Pink		
121 0495 0749 07	Green		
121 0496 0749 10	Yellow		
121 0497 0749 11	Orange		
121 0498 0749 12	Light blue		
121 0499 0749 16	Dark brown		
121 0500 0749 21	Blue		





Sports Temple Ends made of Silicone

For supplementary application on metal temples and inserts of plastic temples.

Assembling range: approx. 1.0 to 1.1 mm

Ø inner: 0.9 mm
 Ø outer: 3.4 mm



"Easy Mounting of Sport Temple Ends"
 (see page F 66)

Thickness of silicone coating: 1.2 mm,
 optimal protection, optimal padding

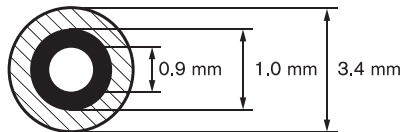

■ Plastic ▨ Silicone

1 pair

Children: Length 75 mm		Adults: Length 90 mm	
Order No.	Colour	Order No.	Colour
120 0940 0717 01	Black	120 0946 0718 01	Black
120 0941 0717 03	Blue	120 0947 0718 03	Blue
120 0942 0717 05	Red	120 0948 0718 16	Brown
120 0943 0717 07	Green	120 0949 0718 19	Bordeaux
120 0944 0717 19	Bordeaux		



B&S Quality temple ends are reassuringly well-engineered. They have no rough spots and the especially thick cushion ensures comfortable wearing.



Sports Temple Ends made of Silicone

For supplementary application on metal temples and inserts of plastic temples.

Assembling range: approx. 1.4 to 1.5 mm

Ø inner: 1.3 mm

Ø outer: 3.8 mm



"Easy Mounting of Sport Temple Ends"
(see page F 66)

Thickness of silicone coating: 1.2 mm,
optimal protection, optimal padding

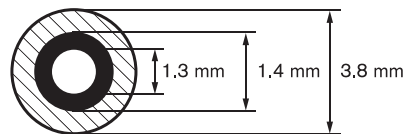

■ Plastic

▨ Silicone

1 pair

Children: Length 75 mm

Adults: Length 90 mm

Order No.	Colour	Order No.	Colour
120 0985 0735 01	Black	120 0994 0736 01	Black
120 0987 0735 03	Navy	120 0996 0736 03	Navy
120 0988 0735 04	Lilac	120 0997 0736 05	Red
120 0989 0735 05	Red	120 0998 0736 16	Brown
120 0990 0735 07	Green	120 0999 0736 19	Bordeaux
120 0991 0735 12	Light blue		
120 0992 0735 16	Brown		
120 0993 0735 19	Bordeaux		



Sports Temple Ends for Adults

For supplementary application on metal temples and inserts of plastic temples.

Assembling range: approx. 1.4 to 1.5 mm

Ø inner: 1.3 mm

Ø outer: 3.0 mm

Length: 90 mm

120 0964 Black
0728 01

 1 pair



without silicone coating

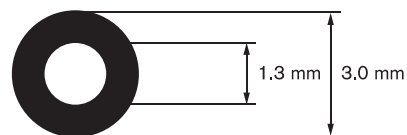

 Plastic



"Easy Mounting of Sport Temple Ends"
(see page F 66)



Please note our PlastiDip – the multipurpose rubber coating on page E 23.



Please also note our heat shrink tubes on page F 77.

MEGALOCK Temple End

Silicone, can be used with plastic and metal temples, firm hold.

Ø inner: 5.9 x 2.7 mm

120 7463-64  10 pairs

120 7463 Black
8903 01

120 7464 Transparent
8903 02

120 7465-66  50 pairs

120 7465 Black
8903 51

120 7466 Transparent
8903 52



Non-slip Temple End

Similar as No. 120 7463–66, but in large pack.

Ø inner: 5.9 x 2.7 mm

120 0969–70  20 pieces

120 0969
0729 10 Transparent

120 0970
0729 11 Black

120 0965–66  100 pieces

120 0965
0729 00 Transparent

120 0966
0729 01 Black



Ø inner: 2.8 x 1.8 mm

120 0971–72  20 pieces

120 0971*
0729 12* Transparent

120 0972*
0729 13* Black

120 0967–68  100 pieces

120 0967*
0729 02* Transparent

120 0968*
0729 03* Black



* Extra small hole
for thin temples

Non-slip Temple Ends, Annular

Material: Silicone

Ø Total: 14.0 mm

Ø inner: 7.0 x 1.0 mm

120 0954–55  20 pieces

120 0954
0722 10 Transparent

120 0955
0722 11 Black



Non-slip Temple Ends, Round with 2 Slot Sizes

Material: Silicone

Ø Total: 14.0 mm

Ø inner: 5.0 x 1.0 mm and 2.0 x 1.0 mm

120 0956–57  20 pieces

120 0956
0723 10 Transparent

120 0957
0723 11 Black





Non-slip Temple Ends for Small Children

Material: Thermoplastic elastomer

Ø-Inner: 5.5 x 3.0 mm

120 0950-52  20 pieces

120 0950
0720 01 Black

120 0951
0720 02 Blue

120 0952
0720 03 Pink

120 0953 **Assortment**
0720 50

 60 pieces (20 pieces per colour)



Non-slip Temple Ends for Children

Silicone, can be used with plastic and metal temples, firm hold.

Suitable for our **Milo & Me** correction frames.

Ø inner: 5.9 x 2.7 mm

120 6744-74  5 pairs

Order No.	Colour	Order No.	Colour
120 6744 85000 00	Black	120 6760 85000 17	Light grey blue
120 6745 85000 01	Dark blue	120 6761 85000 18	Light grey
120 6746 85000 02	Blue	120 6762 85000 19	Light brown
120 6747 85000 03	Middle blue	120 6763 85000 20	Light green
120 6748 85000 04	Light blue	120 6764 85000 21	Light grey green
120 6749 85000 05	Light turquoise	120 6765 85000 22	Light sage
120 6750 85000 06	Dark green	120 6766 85000 23	Light blackberry
120 6751 85000 07	Apple green	120 6767 85000 24	Mauve
120 6752 85000 08	Blackberry	120 6768 85000 25	Peach
120 6753 85000 09	Red	120 6769 85000 26	Orange
120 6754 85000 10	Lilac	120 6770 85000 27	White
120 6755 85000 11	Pink	120 6771 85000 28	Glacial grey
120 6756 85000 12	Dark aquamarine	120 6772 85000 29	Light taupe
120 6757 85000 14	Olive green	120 6773 85000 30	Nude
120 6758 85000 15	Yellow green	120 6774 85000 31	Blush
120 6759 85000 16	Denim light blue		



Windsor Rim

The Windsor Rim is placed on the outer side of the rim and can be glued if required.

Material: Acetate

Ø inner: 1.8 x 0.8 mm

120 1119-21  2 pieces

120 1119

0776 00

Chestnut

120 1120

0776 01

Havana

120 1121

0776 02

Havana dark brown

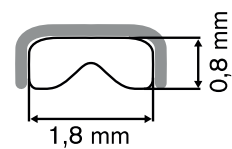
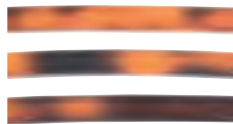

Ø inner: 2.0 x 1.0 mm

120 1122-24  2 pieces

120 1122

0777 00

Chestnut

120 1123

0777 01

Havana

120 1124

0777 02

Havana dark brown

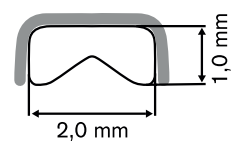

Windsor Rim W-Profile

The Windsor Rim is placed into the groove of the rim and can be glued if required.

Material: Acetate

Ø outer: 1.8 x 0.8 mm

Colour: Havana

120 1079

0751 01

 2 pieces

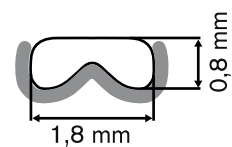

Our matching Windsor rim plier 120 2098 on page B 29 simplifies the adjustment to bridge and end piece.





Long Temple Ends

Length: 135 mm

Acetate Temple End – Thin Type

Black		∅ 1.0 mm	120 0877 0707 01	10 pieces
		∅ 1.2 mm	120 0878 0707 21	10 pieces

Acetate Temple End – Symmetrical Shape

Black		∅ 1.2 mm	120 0879 0708 21	10 pieces
		∅ 1.45 mm	120 0882 0708 41	10 pieces
Brown		∅ 1.2 mm	120 0880 0708 22	10 pieces
		∅ 1.45 mm	120 0883 0708 42	10 pieces
Havana		∅ 1.2 mm	120 0881 0708 23	10 pieces
		∅ 1.45 mm	120 0884 0708 43	10 pieces

Temple End Assortment

Contents: 10 high-quality, modern temple ends in practical snap-lid boxes
We reserve the right to change the assortment.

120 1158
0790 01  100 pieces



TIPS & TRICKS

HEAT SHRINK TUBE

Discreet Protection for Temples and Others

Heat Shrink Tube Assortment

No. 120 1154

Small Scissors

No. 120 2136

OPTOSONIC Cleaning Device

No. 120 3810

Frame Heater OPTIMONSUN

No. 120 3144



approx. 3 minutes

This is how it works

1 CLEANING



2 BENDING



3 REMOVING



4 SELECTING



5 SHORTEN



6 SHRINKAGE



Heat Shrink Tube

For a more comfortable fit, hypo-allergenic, high transparency.
Material: PE

120 1150-53  3 x 1 m

Order No.	Ø inner	Ø after shrinking
120 1150 0786 03	1.5 mm	approx. 0.75 mm
120 1151 0786 05	3.0 mm	approx. 1.50 mm
120 1152 0786 08	5.0 mm	approx. 2.50 mm
120 1153 0786 10	7.0 mm	approx. 3.50 mm



Heat Shrink Tube Assortment

Practical assortment box with 4 different shrinking tube diameters:
6 x 18 cm with diameter 1.5 mm and 7.0 mm
8 x 18 cm with diameter 3.0 mm and 5.0 mm
Material: PE

120 1154
0786 50

Heat Shrink Tube

Shrinking temperature: 120 °C

Ø inner: 3.2 mm Ø after shrinking: 1.5 to 1.6 mm

 3 x 1 m

120 1138 0784 51	Transparent	120 1142 0784 55	Black
120 1139 0784 52	Red	120 1143 0784 56	Grey
120 1140 0784 53	Blue	120 1145 0784 59	Brown



Heat Shrink Tube Assortment

Contents: Each 1x No. 120 1139 and 120 1140 plus each 2x
No. 120 1138; 120 1142; 120 1143 and 120 1145

121 1697  10 pieces of 1 m
0784 34

Heat Shrink Tube

Shrinking temperature: 160 to 170 °C

Ø inner: 1.6 mm Ø after shrinking: 0.8 mm

120 1147-48  3 x 1 m

120 1147 0785 51	Transparent	120 1148 0785 55	Black
----------------------------	-------------	----------------------------	-------

Heat Shrink Tube Temple End Assortment

Length: 80 mm, 1 end closed.
Colour: Black
Shrinking temperature: 150 °C

Ø inner: 3.0 mm Ø after shrinking: 1.5 mm

130 1167  10 pairs
0734 01



Heat Shrink Tube – High transparency

For all metal and plastic temples, hypo-allergenic.
Flat width: 8.0 mm

Ø inner: 5.1 mm Ø after shrinking: approx. 2.8 mm

120 1155  3 x 1 m
0787 08



Temples with Flex Hinges – Nickel Free – Length 140 mm

Gold		120 1529 1039 00	1 pair
		120 1533 1040 00	1 pair
		120 1537 1041 00	1 pair
		120 1541 1042 00	1 pair
Silver		120 1530 1039 01	1 pair
		120 1534 1040 01	1 pair
		120 1538 1041 01	1 pair
		120 1542 1042 01	1 pair
Black		120 1531 1039 02	1 pair
		120 1535 1040 02	1 pair
		120 1539 1041 02	1 pair
		120 1543 1042 02	1 pair
Gun		120 1532 1039 03	1 pair
		120 1536 1040 03	1 pair
		120 1540 1041 03	1 pair
		120 1544 1042 03	1 pair

Temples with RAL Joint (American Joint) – Length 145 mm

Silver		120 1576 1054 11	1 pair
Gold		120 1577 1054 12	1 pair
Black		120 1578 1054 13	1 pair

Standard Temples – Nickel Free – Length 140 mm

Gold		2.5 mm	0.8 mm	120 1525 1038 00	1 pair
		2.5 mm	1.0 mm	120 1545 1043 00	1 pair
		3.2 mm	1.2 mm	120 1549 1045 00	1 pair
		3.6 mm	1.4 mm	120 1553 1046 00	1 pair
Silver		2.5 mm	0.8 mm	120 1526 1038 01	1 pair
		2.5 mm	1.0 mm	120 1546 1043 01	1 pair
		3.2 mm	1.2 mm	120 1550 1045 01	1 pair
		3.6 mm	1.4 mm	120 1554 1046 01	1 pair
Black		2.5 mm	0.8 mm	120 1527 1038 02	1 pair
		2.5 mm	1.0 mm	120 1547 1043 02	1 pair
		3.2 mm	1.2 mm	120 1551 1045 02	1 pair
		3.6 mm	1.4 mm	120 1555 1046 02	1 pair

Acetate Temples – Length 140 mm

Black		3.0 mm	1.0 mm	120 1557 1047 00	1 pair
				120 1558 1047 02	1 pair
Black		3.5 mm	1.0 mm	120 1560 1048 00	1 pair
				120 1561 1048 02	1 pair
Black		5.0 mm	1.2 mm	120 1562 1049 00	1 pair
				120 1563 1049 02	1 pair



Acetate Temples – Length 140 mm



Black

 6.3 mm

 1.2 mm

120 1564
1050 00

1 pair

Transparent

120 1565
1050 01

1 pair

Dark havana

120 1566
1050 02

1 pair

Light havana

120 1567
1050 03

1 pair



Black

 9.0 mm

 1.2 mm

120 1568
1051 00

1 pair

Dark havana

120 1570
1051 02

1 pair



Black

 10.0 mm

 1.4 mm

120 1572
1052 00

1 pair

Dark havana

120 1574
1052 02

1 pair

Light havana

120 1575
1052 03

1 pair

Bridge for Rimless Frames with Sleeves Mounting

- Material: Stainless steel
- For sleeves with an inner diameter of 0.8 mm

120 1579-84   approx. 17 mm





120 1579 1055 00 **Gold** **120 1580** 1055 01 **Silver** **120 1581** 1055 02 **Black** **120 1582** 1055 03 **Gun** **120 1583** 1055 04 **Blue** **120 1584** 1055 05 **Brown**

Spare Temple and Front Hinge for Rimless Frames with Sleeves Mounting – Length 150 mm

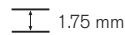

Gold
Silver
Black
Gun
Blue
Brown

Material: Stainless steel

 1.75 mm  0.7 mm
 1.1 mm

120 1585 1056 00 **1 pair**
120 1586 1056 01 **1 pair**
120 1587 1056 02 **1 pair**
120 1588 1056 03 **1 pair**
120 1589 1056 04 **1 pair**
120 1590 1056 05 **1 pair**

Replacement Set Temple and Front Hinge for Rimless Frames with Sleeves Mounting





- Material: Stainless steel
- For sleeves with an inner diameter of 0.8 mm
- Including: 2 temple tips (No. 120 0961), 2 nose pads (No. 120 0450) and 6 sleeves (No. 120 1095)

109 6604-07
120 1602-03

109 6604 1058 00 **Gold**
109 6605 1058 01 **Silver**
109 6606 1058 02 **Black**
109 6607 1058 03 **Gun**
120 1602 1058 04 **Blue**
120 1603 1058 05 **Brown**



Temple with hinge

 1.75 mm  0.7 mm  1.1 mm  150 mm

Bridge

 29 mm  approx. 17 mm



Hingeless Temple for Rimless Frames with Sleeves Mounting – Length 150 mm

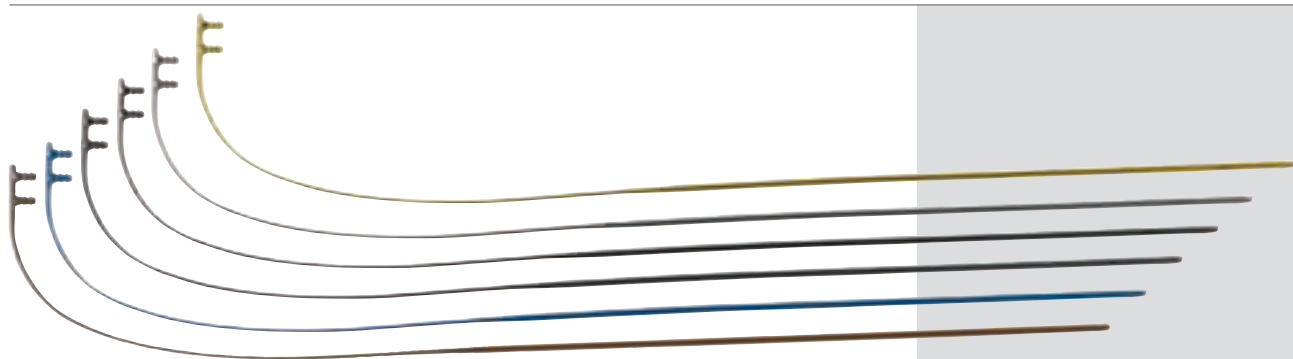

- Gold
- Silver
- Black
- Gun
- Blue
- Brown

Material: Stainless steel

1.6 mm \varnothing 1.0 mm

120 1591 1057 00	1 pair
120 1592 1057 01	1 pair
120 1593 1057 02	1 pair
120 1594 1057 03	1 pair
120 1595 1057 04	1 pair
120 1596 1057 05	1 pair

Replacement Set with Hingeless Temple for Rimless Frames with Sleeves Mounting

- Material: Stainless steel
- For sleeves with an inner diameter of 0.8 mm
- Including: 2 temple tips (No. 120 0914), 2 nose pads (No. 120 0450) and 6 sleeves (No. 120 1095)

120 1604–09

120 1604 1059 00	Gold
120 1605 1059 01	Silver
120 1606 1059 02	Black
120 1607 1059 03	Gun
120 1608 1059 04	Blue
120 1609 1059 05	Brown

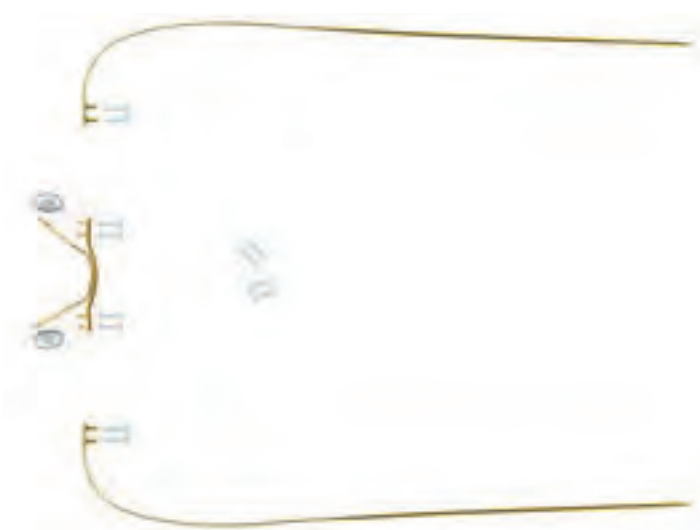

Hingeless temple

1.6 mm \varnothing 1.0 mm 150 mm

Bridge

29 mm  approx. 17 mm

Spare Bridge for Rimless Frames with Screw Mounting

- Material: Stainless steel
- For screw mounting with a diameter of 1.4 mm

120 1650-54  29 mm  approx. 18 mm



Spare Temples for Rimless Frames with Screw Mounting – Length 150 mm



Gold

Material: Stainless steel

120 1656
1066 00

1 pair

Silver

 1.0 mm  1.4 mm

120 1657
1066 01

1 pair

Black

120 1658
1066 02

1 pair

Gun

120 1659
1066 03

1 pair



TENAX Strips

- As interlining to be stuck into the frame groove
- Length: 50 mm, width: 3 mm

120 0981
0733 01

⊥ 0.2 mm

📦 2 sheets of 36 strips



Lens Washer (Liner) – Self-adhesive

- As interlining to be stuck into the frame groove
- Width: 1.7 mm
- Colour: Transparent

120 0980
0733 00

⊥ 0.1 mm 📦 16 m



Lens Washer (Liner) – Acetate

- Colour: Transparent

120 1005
0743 10

⊥ 1.2 mm 📦 approx. 3 m



Lens Washer – CYREX

- Handmade frames insert with V-bevel for optimum use
- Colour: Transparent



120 1006
0743 30

⊥ 1.4 mm

📦 3.5 m

120 1009
0743 35

⊥ 1.4 mm

📦 12 x 3.5 m



You will find our glass adhesive (hypo-tube cement) No. 120 3931 on page E 13.

Lens Washer (Liner) – PVC

- Colour: Transparent



120 1077
0750 00

⊥ 1.6 mm

📦 6 m

120 1078
0750 10

⊥ 1.6 mm

📦 10 x 6 m

120 1080
0752 00

⊥ 1.2 mm

📦 6 m

120 1081
0752 10

⊥ 1.2 mm

📦 10 x 6 m

Lens Ring

High tensile strength (> 300 %) and resistant to brittleness.

- Material: Silicone
- Colour: Transparent

120 1739
1371 00

∅ 26 mm

⊥ 0.85 mm

📦 10 pieces

120 1740
1371 10

∅ 27 mm

⊥ 0.5 mm

📦 10 pieces

f&w



Fitting Strip

120 1727
1368 00

5.0 mm

10 m



Nylon Thread

Ø 0.5 mm

20 cm

120 1736
1370 00

Opaque

100 pieces



Nylon Thread – Transparent

120 1738
1370 02

Ø 0.5 mm

20 m



Nylon Set, 5 Spools

Contents: 8-profile 0.51 and 0.55 mm,
T-profile 1.3 mm,
nylon thread 0.50 and 0.60 mm

120 1735
1369 55

Nylon Thread

• Colour: Transparent

120 1732–34

120 1732 Ø 0.40 mm 20 m
1369 20
120 1733 Ø 0.50 mm 20 m
1369 21
120 1734 Ø 0.60 mm 20 m
1369 23



Nylon Liner 8-Profile

- For metal frames
- Colour: Transparent

120 1728–29

120 1728 0.51 mm 10 m
1369 00

120 1729 0.55 mm 10 m
1369 01

Nylon Liner T-Profile

- For plastic and metal frames
- Colour: Transparent

120 1730–31

120 1730 1.3 mm 5 m
1369 10

120 1731 2.0 mm 5 m
1369 11

Nylon Liner 8-Profile

- For metal frames

120 1726 0.55 mm 2 m
1367 00



You will find our nylon liner tool No. 109 5079 and our nylon thread hook No. 120 2288 on page C 26 and C 27.



Cement Strips – Acetate

120 1004
0742 00  0,36 mm  100 pieces



Acetate Sheets

▪ Colour: Light water

 130 x 80 mm

120 1010
0744 00  0,5 mm  3 pieces

120 1011
0744 10  1,0 mm  3 pieces



Acetate Sheets

A complete frame can be made out of this material. The set includes metal injected temples and 2 hidden hinges. We reserve the right to change the colours.

120 1012
0744 20  150 x 8 x 65 mm



Raw Temples Acetate

Colour: Black



An individual temple can be made out of this material. We reserve the right to change the colour.

120 1013
0744 21  155 x 3,4 x 16 mm  2 pairs



Acetate Material

To make practice pieces in various styles.

120 1014–17
120 1020–23  150 x 6 x 65 mm  2 pieces

one-layered

120 1014
0744 31 Havana

120 1015
0744 32 Black

120 1016
0744 33 Blue

120 1017
0744 34 Transparent

two-layered

120 1020
0744 50 Black/Red

120 1021
0744 51 Dark blue/Transparent

triple-layered

120 1022
0744 60 Red/White/Smokey grey

120 1023
0744 61 Brown/White/Transparent blue

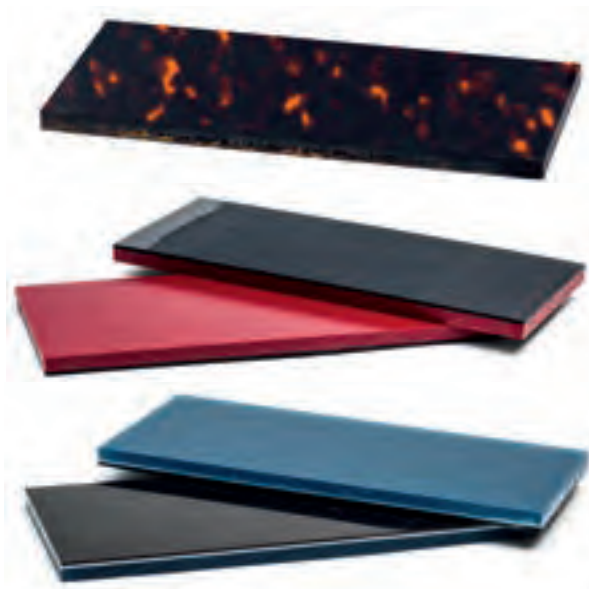

Eye Lid Lifter

For soldering or screwing.

120 0520
0295 00



Eye Wire

Half round, smooth.

120 1706
1361 02



1 m



Soldering Set, Complete Frame

To assemble one complete metal frame with double bridge and golf temples. Eyewires are curved and shaped. We reserve the right to make changes to the composition.

120 1694
1353 00



Soldering Set, Frame Front

Contents: Eyewires, nose bridge, nose pad arms, nose pads, hinges, frame bridge

Eyewires are curved and shaped. We reserve the right to make changes to the composition.

120 1695
1354 03



Flat Wire

- For solder training
- Material: German silver

130 1378
1362 01

4 x 1 mm 1 m



Round Wire

- For solder training
- Material: German silver

120 1719
1363 01

1.5 mm 1 m







ORGANISING AIDS

for the effective treatment plan



- G 2 Presentation Trays
- G 3 Job Bags
- G 5 Price Tags
- G 6 Job Trays
- G 10 Assortment Boxes and Hinged Boxes
- G 14 Cosmetic Mirrors



Presentation Tray

- For the attractive presentation of your products e.g. frames, cases and accessories
- Brushed, stable plastic tray with anti-slip inlay made of soft polymer
- Usable area: 247 x 208 mm
- Contents not included

 300 x 221 x 21 mm

109 6948-49

- | | |
|----------------------------|------------------|
| 109 6948
1433 10 | Black/Light grey |
| 109 6949
1433 11 | Black/Dark grey |

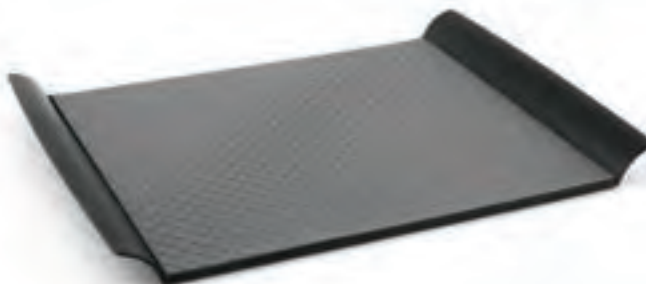

Presentation Box

- For 4 frames
- Made out of aluminium with transparent cover for a quick overview
- Contents not included

 200 x 160 x 55 mm

120 0078 0143 00



Job Bags

- Job bags with separate pocket made of long lasting, semitransparent PP material
- The foldable sides of high-quality Oxford nylon can be stretched up to 4 cm

DIN A5

 155 x 215 x 40 mm

 25 pieces

108 4074–76

108 4074 Green
1434 00
108 4075 Blue
1434 01
108 4076 Red
1434 02

DIN A5 with pocket

 Pocket: 155 x 175 mm

 155 x 215 x 40 mm

 25 pieces

120 1768–70

120 1768 Green
1434 20
120 1769 Blue
1434 21
120 1770 Red
1434 22

DIN A6

 125 x 165 x 40 mm

 25 pieces

120 1765–67

120 1765 Green
1434 10
120 1766 Blue
1434 11
120 1767 Red
1434 12

DIN A6 with pocket

 Pocket: 105 x 110 mm

 125 x 165 x 40 mm

 25 pieces

120 1771–73

120 1771 Green
1434 30
120 1772 Blue
1434 31
120 1773 Red
1434 32



Job Bags for Contact Lenses

- PVC material with Velcro fastener
- Suitable for up to 2 daily or 4 monthly contact lens packages
- Dimensions job bag: 215 x 160 mm
- Dimensions CL packaging: 160 x 110 x 40 mm

 20 pieces

120 1757
1431 10



Job Bag with Zipper

- Suitable for DIN A5 worksheets
- Contents visible due to transparent PE material
- Stable and flexible at the same time
- Easy zipped opening
- For improved organization in the workshop because frame, lenses and file card are in one bag
- Perfect transport solution for external glazing

 175 x 230 mm

 20 pieces

108 4073

1436 00



PVC Bag opticover

- Suitable for DIN A5 worksheets
- Contents visible due to transparent PE material
- Stable and flexible at the same time
- Easy to open
- Rounded corners
- Frames, lenses and worksheet in one bag

 157 x 218 mm

120 1783

1442 00

 20 pieces

120 1784

1442 10

 100 pieces



Foam Inserts for Drawer

For Ophthalmic Frames, Foam Insert Cuts to Size

- Outer measurements (W x H x D): 200 x 3.4 x 50 cm
- Inner measurements (H x D): 25/20 x 44 mm
- 39 compartments

120 1755

1430 20

Dark grey



For Sunglasses, Foam Insert Cuts to Size

- Outer measurements (W x H x D): 200 x 4 x 50 cm
- Inner measurements (H x D): 32/20 x 60 mm
- 30 compartments

120 1756

1430 21

Dark grey



Price Tags

- Price tags for almost all frame models
- To slide onto the temple
- To be used with:
 1. Lens marking pen (clean with spirit)
 2. Labels No. 120 0010

stable

500 pieces

120 0009
0080 01

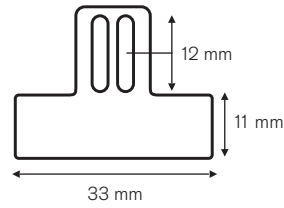

flexible

200 pieces each

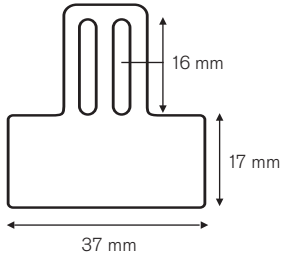

108 1213
0083 00

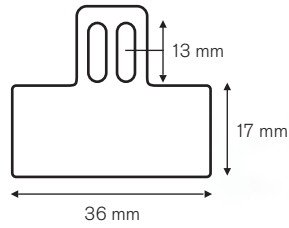

108 1214
0083 10

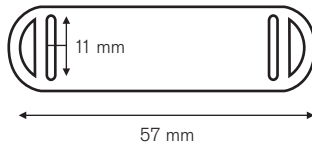

120 0013
0083 40

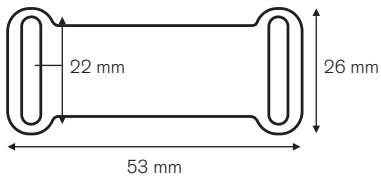

120 0014
0083 60



Self-adhesive Labels

- Suitable for all B & S price tags
- White paper

65 x 10 mm, divisible in two equal parts

264 pieces

120 0010
0081 00



That Fits.

These B & S job trays are produced in Europe using CNC controlled high-tech injection moulding machines. This production technology contributes to a high degree of precision fitting and processing quality. Due to high demand we have now added to the proven standard size an extra high version for sports frames and sunglasses with high curvatures and also their cases.

Job Trays – Large Size

- Flexible and unbreakable ABS plastic
- Both trays fit together
- With label pocket and grip tab
- Both trays are combinable

Coloured

- Inner size (w x h x d): 166 x 45 x 230 mm

Transparent – Extra High – 65 mm

- For high curved frames
- Inner size (w x h x d): 166 x 65 x 230 mm



 170 x 47 x 255 mm

 10 pieces with labels

 170 x 67 x 255 mm

 10 pieces with labels

120 1801-04

120 1801 1454 30	Transparent
120 1802 1454 31	Light blue
120 1803 1454 32	Red
120 1804 1454 33	Grey

120 1800 1452 30

Transparent

Job Tray Labels

- 1-sided foil coating (rewritable)

 10 pieces

120 0007
0077 00 For No. 120 1800 and 120 1801-04

Job Trays

- Flat pack saves on delivery (assemble once)
- Stackable
- With separate division for lenses and small parts
- With label pockets on both sides
- Also for high curved frames
- Material: Polypropylene
- Inner size: (w x h x d): 160 x 60 x 246 mm

 174 x 67 x 260 mm

 10 pieces with labels

108 3848, -50, -51, -52

108 3848 1448 30	Transparent frosted
108 3850 1448 32	Light blue frosted
108 3851 1448 33	Purple frosted
108 3852 1448 34	Fuchsia frosted



All job trays are stackable, have a label pocket and a grip tab.

Job Trays made of Recyclable Plastic

- Both trays are combinable

Average Size

- Extra high – 65 mm**
 - With separate divisions for lenses and small parts
 - Inner size (w x h x d): 162 x 65 x 255 mm
- Opposite you will find the suitable metal stand **No.** 120 1867.

 170 x 70 x 262 mm

 10 pieces with labels

120 1791 Transparent
1447 27



Average Size

- With separate divisions for lenses and small parts
 - Inner size (w x h x d): 162 x 43 x 255 mm
- Opposite you will find the suitable metal stand **No.** 120 1866.

 170 x 48 x 262 mm

 10 pieces with labels

120 1809 Red
1456 05

120 1810 Transparent
1456 27

120 1811 Smoked glass
1456 28



Foam Insert

- For job trays with divisions No. 120 1791 and 120 1809–11
- Lenses can be removed easily – even with short or artificial fingernails
- Protects against chipping
- Colour: Anthracite

 80 x 10 x 80 mm

 20 pieces

120 1812
1456 30



Metal Stand for Job Trays Average Size

- To store 10 (48 mm high) or 8 (70 mm high) job trays
- Easy handling due to a practical carry handle
- **Job trays not included**

 200 x 630 x 240 mm

For 10 job trays No. 120 1809–11

120 1866  2.2 kg
1479 00

For 8 extra high job trays No. 120 1791

120 1867  1.8 kg
1479 01



Job Tray – Small Size

- Inner size (w x h x d): 138 x 36 x 216 mm

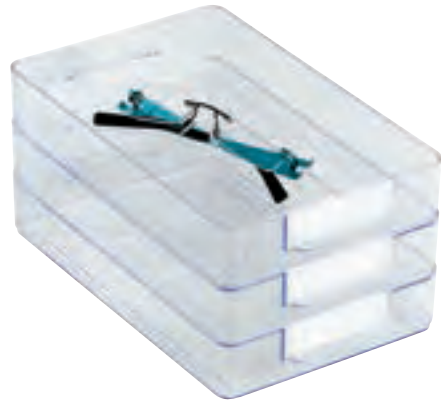

 142 x 39 x 240 mm  10 pieces with labels

120 1808 Transparent
1455 27



Job Tray Labels

- Price tags for almost all frames
- To slide onto the temple
- To be used with:
 1. Lens marking pen No. 120 3049
 2. Labels No. 120 0010
- 1-sided foil coating (rewritable)

 33 x 11 mm (gap 12 mm)  10 pieces

120 0008 For No. 120 1791 and 120 1809–11
0079 00

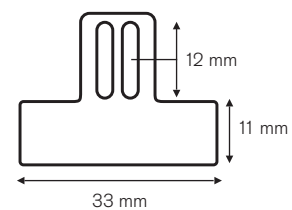

Small Parts Organiser

- With 15 compartments for several spare parts
- Removable dividers
- Material: PP

 105 x 23.5 x 178 mm

120 1776
1435 00



Assortment Box with 5 Compartments

- With 5 compartments for several spare parts
- Material: PP

 130 x 35 x 90 mm

120 1780
1438 00



Assortment Box, medium

- Material: Impact-proof ABS plastic
- Safe locking fastener
- Stackable
- Dividing inserts available separately (No. 120 1789 and 120 1797)

 190 x 37 x 126 mm

120 1788
1445 20



Insert

For assortment box **No. 120 1788**, divided into 9 big compartments.

120 1797
1451 00



Insert

For assortment box **No. 120 1788**, divided into 25 small compartments.

120 1789
1446 00



Small Parts Box

With 7 separately opening compartments.
Colour: Transparent

∅ 8.7 cm

 3 pieces

120 1778
1437 00



Little boxes – great benefits!

Make room, clean up and always ready for work:
The perfect place to store frame parts.

Hinged Boxes

- Transparent, self-closing lid
- All sides interlock
- All sizes fit together



Hinged Boxes

- For nose pads, screws etc.
- Inner size (w x h x d): 37 x 15 x 40 mm

 42 x 18 x 57 mm

 4 pieces

120 1813 White
1457 10

120 1817 Blue
1458 20



Hinged Box Grey

- For temple tips
- Inner size (w x h x d): 57 x 15 x 68 mm

 63 x 18 x 85 mm

 4 pieces

120 1821
1459 30



Hinged Box White

- For screws, washers and nuts
- Inner size (w x h x d): 37 x 15 x 12 mm

 43 x 18 x 29 mm

 4 pieces

120 1816
1457 20



Small Parts Magazine, with 3 Drawers, including Hinged Boxes

- **Complete with:**
- 36 hinged boxes – No. 120 1813, white, **empty**
- 36 hinged boxes – No. 120 1817, blue, **empty**
- 16 hinged boxes – No. 120 1821, grey, **empty**
- Case colour: Light grey

 265 x 108 x 364 mm

120 1824

1459 50



Small Parts Magazine, with 3 Drawers, without Hinged Boxes

- White, blue, grey – for storage of small parts
- Suitable for hinged boxes No. 120 1813, 120 1816, 120 1817 and 120 1821
- Maximum number of hinged boxes per drawer see No. 120 1824
- Case colour: Light grey

 265 x 108 x 364 mm

120 1820

1458 50



Assembly example



Dispensing Cosmetic Mirror

- Diameter: 17 cm
- Height: 23 cm
- With 1 x and 2 x magnification

120 6195
7290 02



Hand Cosmetic Mirror

- Diameter: 17 cm
- Total length: 30 cm
- With 1 x and 2 x magnification

120 6196
7290 03





Brillenfassung: ...
 Gläser / F
 KL N
 Lt. Verordnung Arzt: Refraktion:
 Notizen:
Kunden anrufen

Auftragsnummer: *20513*

Name: *Walter Husterhain*
 Anschrift:
 Telefon:
 E-Mail:

F	R	Sph.	Cyl.	Achse	PD	Höhe	€
N	R	-5.0	-1.0	90	30	25	
	L	-3.5	-1.0	95	32	25	
G	R						
	L						

Basiskurve: R L

Werkstatthinweise (z.B. Facette poliert, besondere Pads, etc.):
- Brillen ausarbeiten

Brillenfassung: *Brillenfassung*

Gläser / F
 KL N

Lt. Verordnung Arzt: Refraktion:

Notizen:
! Rezept abgeben

Summe in €





WHAT WE
DO TODAY
DECIDES WHAT
THE WORLD
WILL
LOOK LIKE
TOMORROW

- Marie von Ebner-Eschenbach -

We encounter the concept of sustainability in almost all areas of life and business. However, it is often reduced to the aspect of environment, but it encompasses far more areas. Ultimately, the aim of sustainable action is to bring the economy, the environment and society into harmony. For us as a Company, this means aligning our corporate success to the three pillars of ecology, economy and social responsibility. As a company with almost 100 years of experience, Breitfeld & Schliekert has always stood for steady growth,

quality and safety. For us, it is a matter of course to enable future generations to further develop established values in a meaningful way and to leave behind a planet worth living on.

Below are some examples of our sustainable commitment, although we must admit that we are far from perfect. New findings and developments constantly present us with new challenges, which we meet with motivation and conviction. We thus continually strive to become a little better every year.



Ecology

Our building is 80% lit using innovative LEDs, with 80% energy savings.

Our packages are shipped CO₂-neutrally by using DHL GO GREEN/GLS THINK GREEN.

We have switched our power supply to 100% green electricity.

We are a certified partner of the DHL Green Logistics Portfolio for sustainable shipping of imported goods from Asia.

We promote digital working and are gradually converting to a paperless office, i.e. no physical dispatch of order confirmations, invoices and Christmas cards, for example.

For our products, we strive to minimize packaging material and outer packaging and to reduce the amount of plastic.

Our printed products are produced on PEFC or FSC certified paper from guaranteed sustainable forestry.



Economy

Our long-term corporate policy is based on securing locations and preserving jobs.

Our newly introduced ERP system optimizes work processes.

Our products are high quality and durable in keeping with the B & S tradition.

Meetings take place predominantly in video conferences, saving time and cost-intensive business trips.

We strictly comply with all current regulations and standards for our entire product portfolio according to the applicable legislation. These include: REACH; RoHS, WEEE and dangerous goods classification according to IATA and ADR.

We reduce fuel and CO₂ emissions through increasing use of electric vehicles and travel by train.



Social responsibility

We guarantee job security with permanent employment contracts for new hires.

We offer training and further education opportunities for our employees and are a recognized training company.

Our corporate culture is based on the principle of diversity and equal opportunities for all.

We allow working from home to balance family and career.

During the coronavirus pandemic, we provided our employees with high-quality masks certified to FFP2 standards and rapid antigen tests free of charge.

Our employees can refuel their vehicles at several e-fueling stations on the company premises.

We also offer our employees the use of a fitness studio as well as the purchase of a company bicycle or e-bikes through a salary conversion plan.

Table of Contents

0–9

4-in-1 Screws

F 35–F 37

A

Abrasive Paper
 Abrasive Rubber
 Abrasive Stones
 Acetate Material
 Acetate Sheets
 Acetate Temple Ends
 Acetate Temples
 Acetone
 Adhesive Pads
 Adhesives
 Air Active Nose Pads
 All Purpose Glues
 Angle Measuring Device
 Anti-Foaming Agent
 Anti-Torsion Foil
 Anvil
 Application Tips
 AQUARIUS Welding and Soldering Unit
 Assortment Boxes and Inserts
 Axis Layout

E 32
 E 32
 E 9
 F 86
 F 86
 F 60–F 62, F 75
 F 79–F 80
 E 17
 E 4–E 7
 E 12–E 14
 F 6
 E 14
 D 29
 E 9
 E 8
 C 15
 E 16
 A 33
 G 10–G 11
 D 28

B

Bending Pliers
 Binocular Confirmation Test
 Bionic Thumb
 Blocking Pads
 Buffing Wheels
 Burnishing Wax

B 12–B 14
 D 9
 B 30–B 31
 E 2–E 3
 E 28–E 29
 E 30–E 31

C

Caliper Gauges
 Caps for Rimless Frame Screws
 Chains and Cords
 Chamfering Unit with V-Facet
 Chipping Pliers
 CLAVULUS + Accessories
 Cleaner for Spectacle Lenses
 Cleaning Brush
 Cleaning Concentrate
 Clip-on
 Colour Charts
 Comfort Nose Pads
 Compressed Air Spray
 Confirmation Test
 Consumer Ultrasonic Baths
 Contact Lens Cases + Accessories
 Cosmetic Mirror
 CR 39 Lenses
 Cross Cylinder
 Cutting Pliers

D 24
 F 51
 see Brochure
 “Reading Fashion
 for Everyday Use!”
 A 24
 B 35
 A 42–A 45
 E 17
 E 32
 E 19
 see Brochure
 “Enjoy the Sun!”
 D 10
 F 6
 E 18
 D 9
 see Brochure “Stand
 out from the Rest!”
 D 18–D 19
 G 14
 see Brochure
 “Enjoy the Sun!”
 D 8
 B 25–B 26, B 39–B 42

D

De-Blocking Pliers
 Diamond Coated Tools
 Diamond Hand Edgers
 Diamond Wheels for Lens Groover
 Digital Pupillometers
 Disinfectant Wipes
 Dispensing Cosmetic Mirror

B 36–B 37
 C 35
 A 24–A 25
 A 23
 A 2–A 3
 see Brochure
 “Cleaning & Hygiene”
 G 14

Diving Masks

see Brochure
 “Everything for
 Water Sports!”
 F 49–F 50
 E 9
 C 29
 C 29
 A 28–A 32
 A 31
 C 33, C 35
 C 32, C 34–C 35
 E 20

Dome Nuts
 Dressing Stones
 Drilled Hole Reamer
 Drill Hole Chamfer Tool
 Drilling Machines + Accessories
 Drilling Stand
 Drill Millers
 Drills
 Dyes

E

Electrolyte
 Elmasonic P30H
 End Caps
 Eye Lid Lifter
 Eye Patches
 Eye Patches Picolo
 Eye Rim Wire

E 35
 A 12
 F 51
 F 87
 D 14, D 16–D 17
 D 16–D 17
 F 87

F

File Handles
 Files
 Filing Brush
 Filing Vice
 Fine Line Ruler
 Fitting Strip
 Flat Nose Pliers
 Flat Snipe Nose Pliers
 Flat Wire
 Flex Hinges + Inner Spring
 Fluid Dispenser
 Fluxes
 Foam Insert for Job Trays
 Foam Inserts for Drawer
 Foil Pen
 Formers
 Fotochromic Tester
 Frame and Small Part Boxes
 Frame Heaters
 Fret Saw + Accessories
 Front Cutter

C 39
 C 38–C 41
 E 32
 C 42
 D 28
 F 85
 B 17–B 18
 B 16–B 17
 F 87
 F 55
 E 16
 E 35
 G 8
 G 4
 E 10
 D 28
 A 38
 G 10–G 13
 A 16–A 19
 C 43
 B 25–B 26, B 39–B 40

G

Gas Cartridge
 Glass Adhesive
 Glass Cement
 Glass Cutter
 Glass Glue
 Glue
 Gold Solder
 Graphite Pencil
 Grinding Additive
 Grinding Sponge Disc
 Gripper
 Groove Miller

E 34
 E 13
 E 13
 C 19
 E 13
 E 12–E 14
 E 37
 E 10
 E 9
 E 33
 C 16
 C 33

H

Hack Saw
 Hammer
 Hand Cosmetic Mirror
 Hand Edgers
 Handheld CLAVULUS
 Heatstop
 Hex Driver
 HG Power Glue
 Hidden Hinges
 High-Precision Files
 Hilco Logic® Pads

C 43
 C 18
 G 14
 A 24–A 25
 C 13
 E 35
 C 8
 E 13
 F 57
 C 38–C 39
 F 12

Hilco Logic® Screws F 44
Hinge Adjusting Pliers B 28–B 29
Hinged Boxes G 12–G 13
Hinges F 54–F 57
Hinge Setting Pliers B 28
Holding Pliers B 3, B 8–B 9
HSS Drills C 32
Hydrotac Stick-on Reading Segment D 13
Hygiene Box + Accessories A 39
Hypo-allergenic Special Nose Pads F 12–F 13

I

ic! berlin Nose Pads F 11
ic! berlin Temple Tips and Tube Sets F 65
Inclination Pliers B 6–B 7
Ink Paste E 25
Ink Remover Pen E 10
Instant Adhesives E 12, E 14
Interliner F 84
Inverted Holder for UV Glues E 11
Ishihara Colour Chart D 10

J

Job Bags G 3–G 4
Job Trays G 6–G 9

L

LANG Fixation Cube D 10
Lens Aligner B 34
Lens Blocks E 2–E 3
Lens Clock D 22
Lens Deco Pens E 26
Lens Drilling Machine + Accessories A 28
Lens Dyes E 20
Lens Foils D 12
Lens Grip E 8
Lens Groovers + Accessories A 20–A 23
Lens Liner F 84
Lens Marking Pens E 10
Lens Protection E 8
Lens Protection Henry C 24–C 25
Lens Protection Shim Plate C 25
Lens Ring F 84
Lens Ruler D 29
Lens Washers F 84
Lens Washer TENAX F 84
Lensmeter + Accessories A 6–A 8
LessStress Drilling Machine A 29
Liquid Dispenser E 16
Liquid Lining E 13
Loctite E 12–E 15
Logic® Pads F 12
Logic® Screws F 44

M

Magnetic Mat for Rimless Work D 25
Magnetic Tool Bar B 47
Mandrel C 23
Marking Needle E 32
Marking Pens E 10
Marking Pliers B 38
Marking Tool “APP” F 19
Marking Tool The Cube D 26–D 27
Matsubara Colour Chart D 10
Measurement Tool for Holes C 23
Microfibre Cloths see Brochure “Stand out from the Rest!”
Millers C 30, C 33–C 36
Mixing Bowl and Stand E 16
Mounting Set Nose Pad Arms F 19

N

Needle Files C 40–C 41
Neutraliser E 21
Non-slip Temple Ends F 71–F 73
Nose Bridges F 7, F 12
Nose Pad Adjusting Pliers B 20–B 21
Nose Pad Arms F 18–F 21
Nose Pad Cushion F 15–F 17
Nose Pad Removing Pliers B 18
Nose Pads F 2–F 14
Nose Pads for Ray Ban Frames F 14
Nose Protection see Brochure “Safety for your Eyes!”
Nutdrivers C 4–C 5, C 7, C 28–C 29
Nutdriver Sets C 12
Nut Gripper C 16
Nuts F 49
Nylon Eyewire Shaper B 10–B 11
Nylon Liner F 85
Nylon Liner Tool C 26–C 27
Nylon Thread F 85
Nylon Thread Hook C 27

O

Occluder D 10, D 14
Occlusive Foils D 15
Ocular Lensmeter A 8
Oil E 17
Oil Dropper E 17
Ophthalmic Lenses D 11–D 12
OptiCar Nutdriver C 5
OptiCar Screwdriver C 3
OPTIFORMA Frame Heater A 14–A 15
OPTIMONSUN Frame Heater A 16–A 17
OPTOCLEAN E 19
OPTOSONIC Cleaning Devices A 10–A 11
Organizer for Frame and Spare Parts G 10–G 11
Oxygen Bottle E 34

P

Pad Arms F 18–F 21
Pad Removing Pliers B 18
Parallel Pliers B 2–B 3
PD Scales D 29
Peening Pliers B 33
Pens E 10
Plasti Dip E 22–E 23
Plastic Bottle E 16
Plastic Glues E 14
Plastic Nose Pads F 11
Plastic Strip F 86
Pliers eLite B 4–B 37
Pliers Handles B 46
Pliers Standard B 4–B 41
Pliers Stands B 45–B 46
Pocket Caliper D 24
Polariscope A 36–A 37
Polarised Clip-ons D 2–D 3
Polarising Lenses see Brochure “Enjoy the Sun!”
Polishing Motors + Accessories A 26–A 27
Polishing Wax E 30–E 31
Polycarbonate Pads F 11
Polycarbonate Plano Lenses see Brochure “Enjoy the Sun!”
Power Testing Bars D 8
PP Temple End F 60
Precision Tool Holder C 37
Presentation Box G 2
Presentation Tray G 2
Pressing Pliers B 22–B 24
Pressure Mount Pliers B 3, B 22–B 24

Table of Contents

Pressure Mount Removing Pliers
 Price Tags
 Proformic UV Glue
 Progressive Marking Reader
 Protection Foil
 Pupilometer
 PVC Pads

B 22–B 23
 G 5
 E 11
 A 38
 E 8
 A 2–A 3
 F 8–F 9

R

Reach Nuts
 Reading Glasses

 Reading Segments
 Reamer Holder
 Reamers
 Repair Colours
 Repair Pens
 Retractable Graphite Pencil
 Revolving and Plastic Depot
 Rim Joints
 Rimless Frame Adjusting Pliers
 Rimless Frame Screws
 Rivet Hinges
 Rivets
 Rook Anvil
 Round Snipe Nose Pliers
 Round Wire
 Ruler

F 51
 see Brochure
 "Reading Fashion
 for Everyday Use!"
 D 13
 C 37
 C 21
 E 25
 E 24
 E 10
 C 3, C 5–C 7
 F 57
 B 27
 F 38
 F 56
 F 57
 C 15
 B 15
 F 87
 D 28–D 29

S

Safety Goggles

 Saw Blades
 Saws
 Scalpel
 Scissors
 Scraper
 Screw Assortments
 Screw Cutter
 Screw Driving Tweezer
 Screw Grip
 Screw Holder
 Screw Remover
 Screw Securing
 Screw Taps
 Screwdriver
 Screwdriver Set
 Screwdriver with 5 Functions
 Screwdriver with Blade Storage
 Screws
 Screws for Ray Ban Frames
 Screws with Screw Securer
 Segheight Gauge
 Self-adhesive Labels
 Self-cutting Screws
 Shrinking Tubes
 Shrinking Tubes for Plier Handles
 Side Cutters
 Side Protection – easy to cut
 Silicone Nose Pads
 Silicone Pad
 Silicone Spray
 Silicone Temple Ends
 Silver Palladium Wire
 Silver Solder
 Silver Solder Paste
 Size Testing Pliers
 Sleeve Removing Tool
 Sleeves for Rimless Frames
 Sleeves Removing Pliers
 Small Metal Screwdriver
 Small Parts Organizing Boxes
 Small Tools Assortment

see Brochure "Safety
 for your Eyes!"
 C 43
 C 43
 C 20
 C 20
 C 18
 F 47–F 48
 B 27, C 28–C 29
 B 44, C 15
 E 13
 C 16–C 17
 C 13
 E 15
 C 22
 C 2–C 11
 C 2
 C 11
 C10
 F 22–F 48
 F 39
 F 43–F 46
 D 24
 G 5
 F 45
 F 76–F 77
 B 46
 B 26, B 39–B 42
 D 14
 F 4–F 8
 C 30
 E 18
 F 63–F 64
 E 34
 E 36
 E 35
 B 19
 C 27
 F 52–F 53
 B 22–B 23
 C 11
 G 10–G 13
 C 31

Snap Lid Boxes
 Solder
 Solder Dispenser
 Solder Hinges
 Soldering Sets
 Soldering Units + Accessories
 Spare Parts for Rimless Frames
 Special Cleaner for Spectacle Lenses
 Special Front Cutter
 Special Nose Pads
 Special Screws
 Spectacle Chains and Cords

G 12–G 13
 E 35–E 37
 E 34
 F 54
 F 87
 A 33–A 35
 F 81–F 83
 E 17
 B 25
 F 11–F 14
 F 35–F 46
 see Brochure
 "Reading Fashion
 for Everyday Use!"
 C 32
 F 15
 see Croakies Catalog
 see Leader Catalog
 F 66–F 70
 B 43–B 44
 F 41–F 43
 F 55
 E 14
 C 18
 see Brochure
 "Everything for
 Water Sports!"

Spiral Drills
 Sponge Cushions
 Sport Bands
 Sport Frames
 Sports Temple Ends
 Spring Hinge Pliers
 Spring Hinge Screws
 Spring Hinges + Inner Spring
 Superglue Liquid
 Swarf Removal Tool
 Swimming Goggles

T

Table Drilling Machine
 TAKUBOMATIC Hand Edger
 TAKUBOMATIC Lens Groover
 Teaching Sets
 Temple Adjusting Pliers
 Temple Ends
 Temple Hinge Screws
 Temples
 Temples with Flex Hinges
 Temples with RAL Joint
 Test Lens
 Test Strip
 The Cube Marking Tool
 THERA°PEARL® Eye-ssential™ Mask
 Thickness Gauge
 Third Hand
 Third Hand Stand (with Nut Gripper)
 Tinting Unit
 Tip Assortment
 Titanium Nose Pads
 Titanium Wire
 Tool Bag
 Tool Case
 Tool Holder
 Tool Kit for Rimless Frames
 Torx Driver
 Torx Screws
 TPE Pads
 Transmittance Measuring Device
 Trial Frames
 Trial Lens Set
 Trident Pliers
 Tweezers

A 31
 A 25
 A 20–A 21
 F 86–F 87
 B 32
 F 58–F 73, F 75
 F 45
 F 78–F 83
 F 78
 F 78
 D 24
 D 8
 D 26–D 27
 D 20
 D 23
 C 14
 C 14
 A 41, E 20
 E 16
 F 13
 E 34
 B 47
 B 47
 C 37
 C 29
 C 9
 F 40
 F 7
 A 38
 D 2–D 4
 D 5–D 7
 B 14
 C 16–C 17

U

UB4 & UB6
 Ultrasonic Baths

 Ultrasonic Cleaners + Accessories
 Universal Adhesives
 Universal Pen
 UV Filter Additive
 UV-Fix Glue
 UV Lamp for Photochrom. Lenses
 UV Lamps for UV Glues

D 2–D 3
 see Brochure "Stand
 out from the Rest!"
 A 12–A 13
 E 12–E 13
 E 10
 E 21
 E 11
 A 38
 A 40

V

Vario Block
VENTILETTE Frame Heater
Vices

E 3
A 19
C 42

W

Washers
Welding Accessories
Windsor Rim Pliers
Windsor Rims
Workshop Files

F 50–F 51
E 34
B 29
F 74
C 38–C 41



TIPS & TRICKS

- B 12 Bending Pliers
- B 22 Rimless Frame Pliers
- B 30 Bionic Thumb
- B 43 Spring Hinge Pliers
- C 24 Lens Protection Henry
- C 26 Nylon Liner Tool
- C 28 Screw Cutter
- D 11 Prism Foils
- D 26 The Cube
- E 22 Plasti Dip
- E 27 Polishing
- F 10 Silicone Nose Pads Minifits
- F 16 Self-adhesive Nose Pad Cushion
- F 18 Nose Pad Arms
- F 35 4-in-1 Screws
- F 66 Sport Temple Ends
- F 76 Heat Shrink Tube

Explanation of symbols



Note



Diameter



Thickness
eye wire



Length or width



Thickness



Weight



Height



Thickness
lens washer



Packing unit:
piece/pair



Dimensions
width × depth or
width × height × depth



This catalogue is again printed on certified paper – produced by sustainable forest management.
For more information about the B&S environment initiative visit our homepage: www.b-s.de



OUR CONTRIBUTION TO THE ENVIRONMENT PAPER FROM SUSTAINABLE FORESTRY.



Our new catalogue has 320 pages. With 7 languages and a total circulation of 15,950 catalogues, that makes approx. 5.1 million pages. With the estimated amount of paper needed, that makes the proud sum of approx. 318,750 m² of paper. That is almost approx. 31 tonnes of paper.

The printer purchases this paper from a paper manufacturer, which in turn was obtained from nature. We now have the opportunity to not just talk about being environmentally conscious but also acting accordingly.

Thus, together with the printer, we have selected paper with a seamless processing chain for production of the B&S catalogues: **Inapa Bavaria. This wood-containing photo paper is – like the printer itself – certified by PEFC.**

The goal of PEFC is the documentation and improvement of sustainable forest management with respect to economically viable, ecological and social standards. Companies certified by PEFC show dedication to the environment and responsibility when working with the raw material of wood.

At B&S we consider it essential to act responsibly with the limited resources of our earth. And there you have it in "black and white".

All contents of this catalogue, in particular texts, images and graphics are subject to copyright law and, to the best of our knowledge, correct at the time of printing. Unless stated otherwise, the copyright lies with Breitfeld & Schliekert GmbH. Please contact us if you want to use or publish content for your own purposes.

We cannot be held responsible for any errors in description or illustration and reserve the right to change specifications without notice.

© Breitfeld & Schliekert 2022/23 | All rights reserved

Project Management Katrin Gaarz, Bastian Trumpfheller, Christine Füger, Stefanie Mache, Annika Angerer
Creation / Artwork Bettina Wilke, Roswitha Pitz, Kim Rosenbrock, Margret Spitz, Britta Wendland
Photo Behrendt & Rausch, Martin Joppen Photographie
Production Bonifatius GmbH Druck | Buch | Verlag, Paderborn



B & S is at your service, world wide